

Features

- Batch process design, excellent power dissipation offers better reverse leakage current and thermal resistance.
- Wide zener reverse voltage range 2.7V to 200V.
- Small package size for high density applications.
- Ideally suited for automated assembly processes.
- Lead-free parts meet environmental standards of MIL-STD-19500 /228
- Compliant to Halogen-free

Mechanical data

- Epoxy : UL94-V0 rated flame retardant
- Case : Molded plastic, DO-214AC/ SMA
- Terminals :Plated terminals, solderable per MIL-STD-750, Method 2026
- Polarity : Indicated by cathode band
- Mounting Position : Any

Package outline

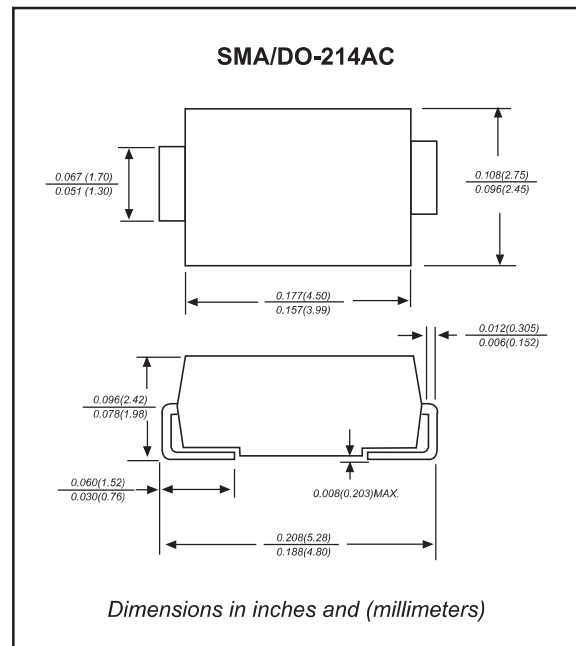

Maximum ratings (at $T_A=25^{\circ}\text{C}$ unless otherwise noted)

PARAMETER	CONDITIONS	Symbol	MIN.	TYP.	MAX.	UNIT
Forward voltage	$I_F = 200 \text{ mA}$	V_F			1.20	V
Power dissipation	$T_L = 50^{\circ}\text{C}$	P_D			2.0	W
Operating junction temperature range		T_J	-55		+150	$^{\circ}\text{C}$
Storage temperature range		T_{STG}	-65		+175	$^{\circ}\text{C}$

Electrical characteristics (at T_A=25°C unless otherwise noted)

TYPE	Nominal Zener Voltage		Maximum Zener Impedance			Maximum Reverse Leakage Current		Maximum DC Zener Current
	V _Z @ I _{ZT}	I _{ZT}	Z _{ZT} @ I _{ZT}	Z _{ZK} @ I _{ZK}	I _{ZK}	I _R @ V _R	I _{ZM}	
	(V)	(mA)	(Ω)	(Ω)	(mA)	(μA) (V)	(mA)	
SZ452H	2.7	80	10	400	1.0	100 1.0	660	
SZ453A	3.0	160	8.0	400	1.0	100 1.0	600	
SZ453D	3.3	145	8.0	400	1.0	80 1.0	545	
SZ453G	3.6	139	5.0	400	1.0	80 1.0	504	
SZ453J	3.9	128	5.0	400	1.0	50 1.0	468	
SZ454D	4.3	116	4.5	400	1.0	50 1.0	434	
SZ454H	4.7	106	4.5	550	1.0	50 1.0	386	
SZ455B	5.1	98.0	3.5	600	1.0	50 1.0	356	
SZ455G	5.6	89.5	2.5	500	1.0	50 2.0	324	
SZ456C	6.2	80.5	1.5	700	1.0	50 3.0	292	
SZ456I	6.8	73.5	2.0	700	1.0	50 4.0	266	
SZ457F	7.5	66.5	2.0	700	0.5	50 5.0	242	
SZ458C	8.2	61.0	2.3	700	0.5	50 6.0	220	
SZ459B	9.1	55.0	2.5	700	0.5	50 7.0	200	
SZ4510	10	50.0	3.5	700	0.25	50 7.6	182	
SZ4511	11	45.5	4.0	700	0.25	50 8.4	166	
SZ4512	12	41.5	4.5	700	0.25	1.0 9.1	152	
SZ4513	13	38.5	5.0	700	0.25	0.5 9.9	138	
SZ4514	14	35.7	5.5	700	0.25	0.5 10.6	130	
SZ4515	15	33.4	7.0	700	0.25	0.5 11.4	122	
SZ4516	16	31.2	8.0	700	0.25	0.5 12.2	114	
SZ4517	17	29.4	9.0	750	0.25	0.5 13.0	107	
SZ4518	18	27.8	10	750	0.25	0.5 13.7	100	
SZ4519	19	26.3	11	750	0.25	0.5 14.4	95	
SZ4520	20	25.0	11	750	0.25	0.5 15.2	90	
SZ4522	22	22.8	12	750	0.25	0.5 16.7	82	
SZ4524	24	20.8	13	750	0.25	0.5 18.2	76	
SZ4527	27	18.5	18	750	0.25	0.5 20.6	68	
SZ4530	30	16.6	20	1000	0.25	0.5 22.5	60	
SZ4533	33	15.1	23	1000	0.25	0.5 25.1	55	
SZ4536	36	13.9	25	1000	0.25	0.5 27.4	50	
SZ4539	39	12.8	30	1000	0.25	0.5 29.7	47	
SZ4543	43	11.6	35	1500	0.25	0.5 32.7	43	
SZ4547	47	10.6	40	1500	0.25	0.5 35.8	39	
SZ4551	51	9.8	48	1500	0.25	0.5 38.8	36	
SZ4556	56	9.0	55	2000	0.25	0.5 42.6	32	
SZ4562	62	8.1	60	2000	0.25	0.5 47.1	29	
SZ4568	68	7.4	75	2000	0.25	0.5 51.7	27	
SZ4575	75	6.7	90	2000	0.25	0.5 56.0	24	
SZ4582	82	6.1	100	3000	0.25	0.5 62.2	22	
SZ4591	91	5.5	125	3000	0.25	0.5 69.2	20	
SZ45B0	100	5.0	175	3000	0.25	0.5 76.0	18	
SZ45B1	110	4.5	250	4000	0.25	0.5 83.6	17	
SZ45B2	120	4.2	325	4500	0.25	0.5 91.2	15	
SZ45B3	130	3.8	400	5000	0.25	0.5 98.8	14	
SZ45B4	140	3.6	500	5500	0.25	0.5 106.4	13	
SZ45B5	150	3.3	575	6000	0.25	0.5 114.0	12	
SZ45B6	160	3.1	650	6500	0.25	0.5 121.6	11	
SZ45B7	170	2.9	675	7000	0.25	0.5 130.4	11	
SZ45B8	180	2.8	725	7000	0.25	0.5 136.8	10	
SZ45B9	190	2.6	825	8000	0.25	0.5 144.8	10	
SZ45D0	200	2.5	900	8000	0.25	0.5 152.0	9.0	

Notes :

- (1) The type number listed have a standard tolerance on the nominal zener voltage of ± 5.0%, altered the fourth number of type from " 5 " for ± 5.0% tolerance to be " 0 " for ± 10% tolerance.

Rating and characteristic curves

FIG.1 Typical Thermal Response L

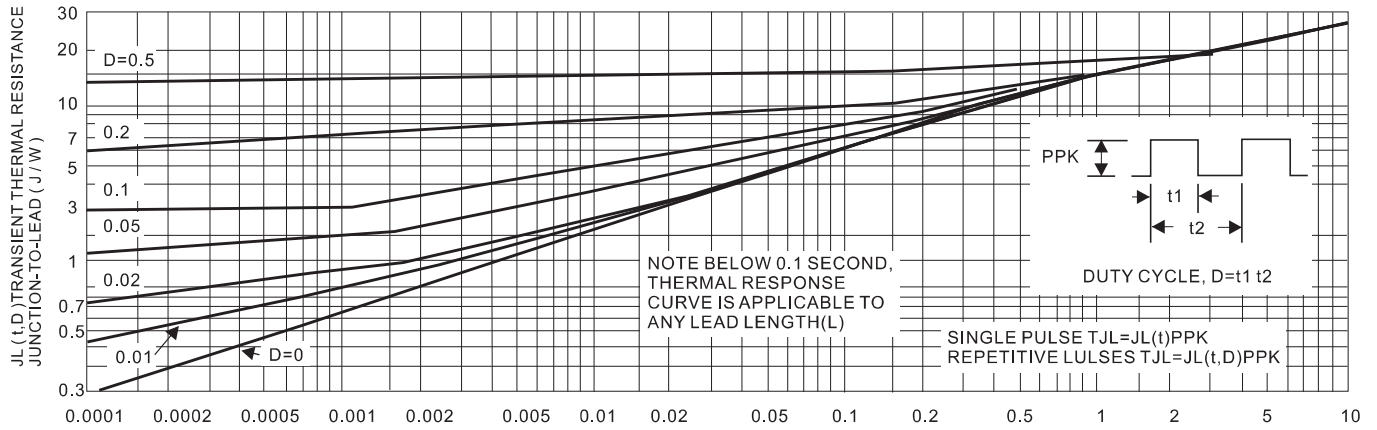

Fig. 2 Maximum Surge Power

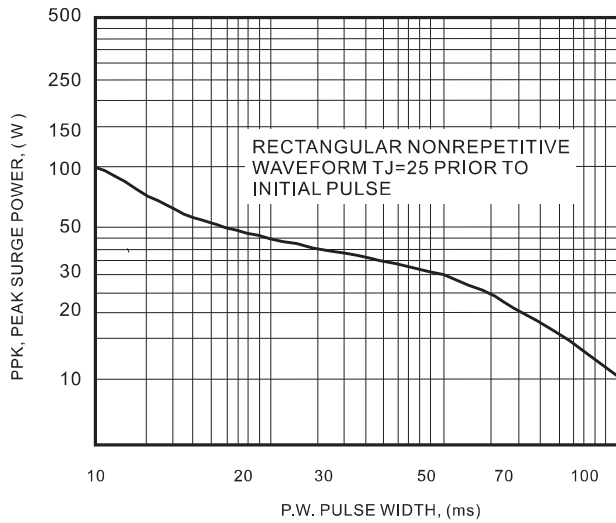

Fig. 3 Maximum Surge Power

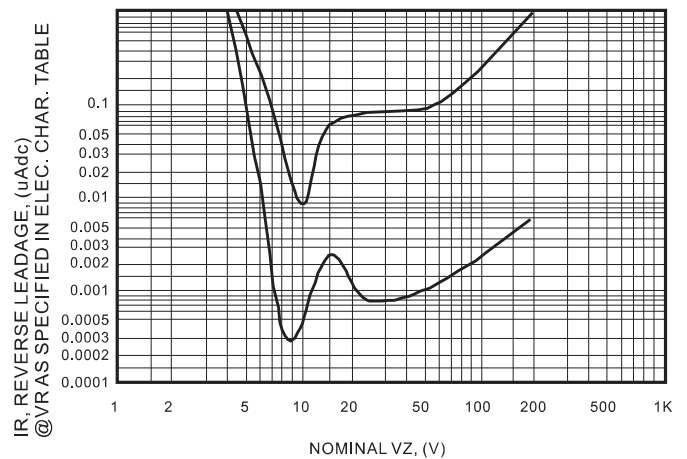

FIG.4 Units To 200 Volts

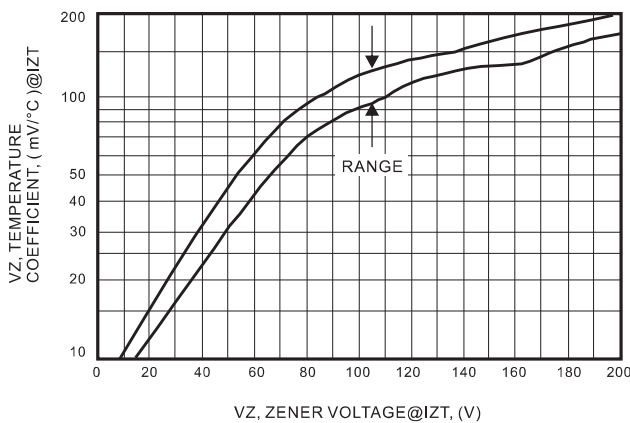
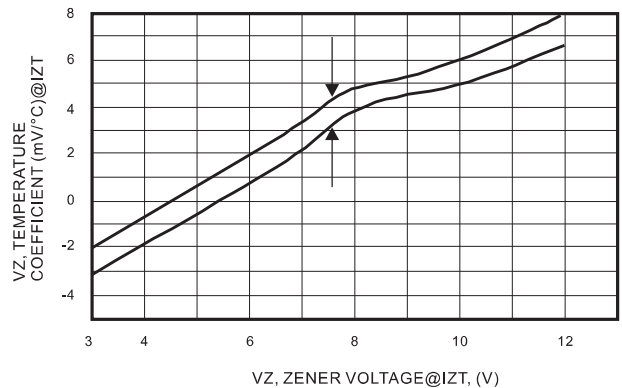

Fig 5. Units To 12 Volts



Rating and characteristic curves

FIG.6 VZ = 3.9 Thru 10 Volts

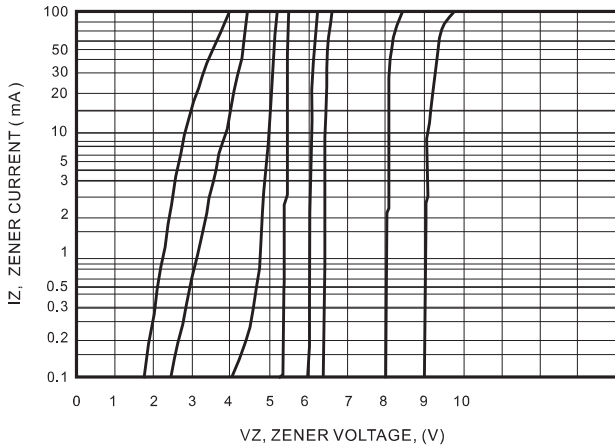

FIG.7 VZ = 12 Thru 82 Volts

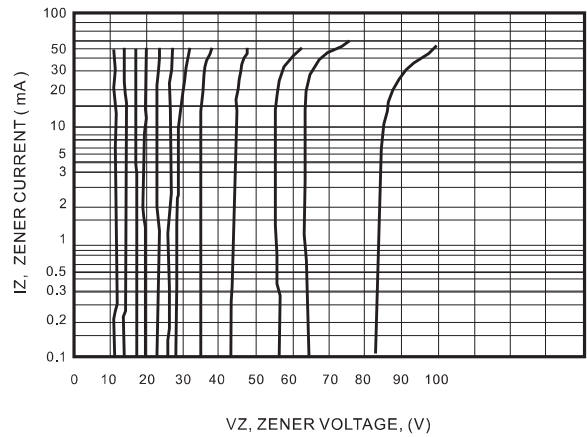

Fig. 8 VZ = 100 Thru 200 Volts

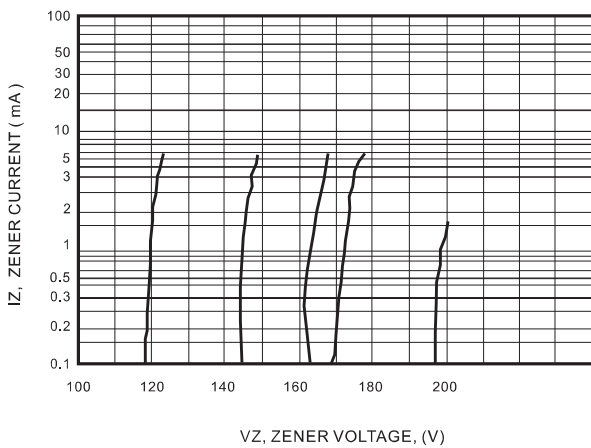
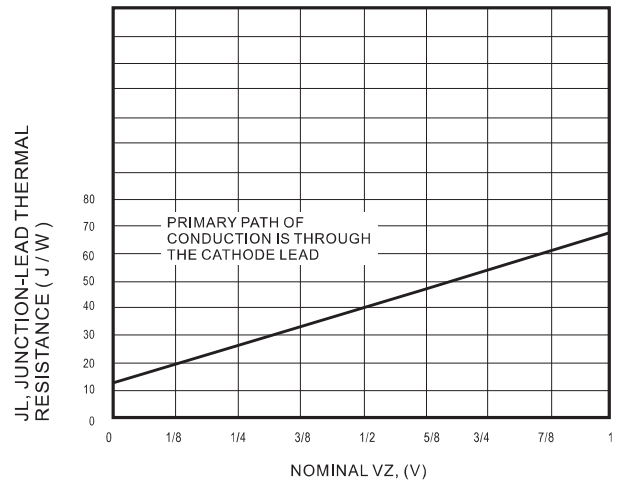

Fig. 9 Typical Thermal Resistance



Pinning information

Pin	Simplified outline	Symbol
Pin1 cathode Pin2 anode		

Marking

Example P/N:	Marking code
SZ4512	

Suggested solder pad layout

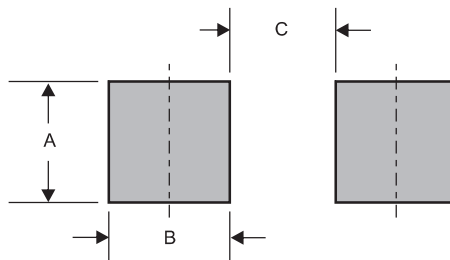

Dimensions in inches and (millimeters)

PACKAGE	A	B	C
SMA	0.110 (2.80)	0.063 (1.60)	0.087 (2.20)