

Features

- Ultra Low Forward Voltage Drop .
- Very low profile-typical height of 1.10mm
- Low Power Losses,High Efficiency Operation
- Low Thermal Resistance Package.
- High Operating Junction Temperature.
- Compliant to Halogen-free.

Mechanical data

- Epoxy:UL94-V0 rated flame retardant
- Case : TO-277B , molded Plastic
- Terminals:Solderable per MIL-STD-750,Method 2026
- Marking:SU10100

Package outline

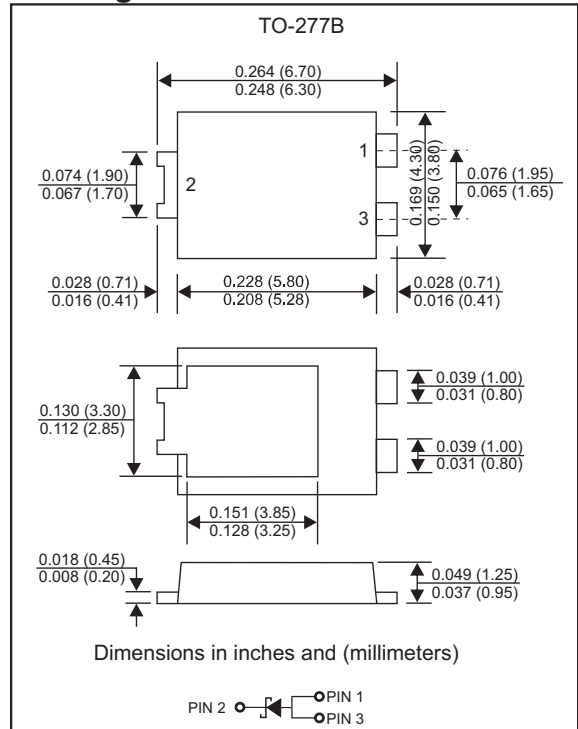

Maximum ratings (AT $T_A=25^\circ\text{C}$ unless otherwise noted)

Parameter	Symbol	SU10100-T	Unit
DC Blocking Voltage	V_{DC}	100	V
Working Peak Reverse Voltage	V_{RWM}	100	V
Repetitive Peak Reverse Voltage	V_{RRM}	100	V
RMS Reverse Voltage	V_{RMS}	70	V
Average Forward Rectified Current	$I_{F(AV)}$	10.0	A
Peak Forward Surge Current,8.3ms Half Sine-wave($T_A=25^\circ\text{C}$)	I_{FSM}	250	A
Operating junction temperature range	T_J	-55 to +150	$^\circ\text{C}$
Storage temperature range	T_{STG}	-55 to +175	$^\circ\text{C}$

Electrical Characteristics (AT $T_A=25^\circ\text{C}$ unless otherwise noted)

Parameter	Test Conditions	Symbol	MIN.	TYP.	MAX.	Unit
Reverse Breakdown Voltage	$I_R=0.5\text{mA}, T_J=25^\circ\text{C}$	V_B	100	-	-	V
Forward voltage	$I_F=5\text{A}, T_J=25^\circ\text{C}$	V_F	-	0.47	-	V
	$I_F=10\text{A}, T_J=25^\circ\text{C}$		-	0.55	0.63	
Reverse current	$V_R=100\text{V}, T_J=25^\circ\text{C}$	I_R	-	0.055	0.3	mA
	$V_R=100\text{V}, T_J=100^\circ\text{C}$		-	5	15	

Thermal Characteristics

Parameter	Symbol	SU10100-T	Unit
Typical thermal resistance junction to ambient (Note 1)	$R_{\theta JA}$	80	$^\circ\text{C/W}$
Typical thermal resistance junction to case (Note 1)	$R_{\theta JC}$	15	$^\circ\text{C/W}$

Note 1: Mounted on FR-4 PCB copper pad area. Cathode pad dimensions 4.95mm x 3.4mm.
Anode pad dimensions 1.55mm x 5.0mm.

Rating and characteristic curves

Fig.1 - Forward Current Derating Curve

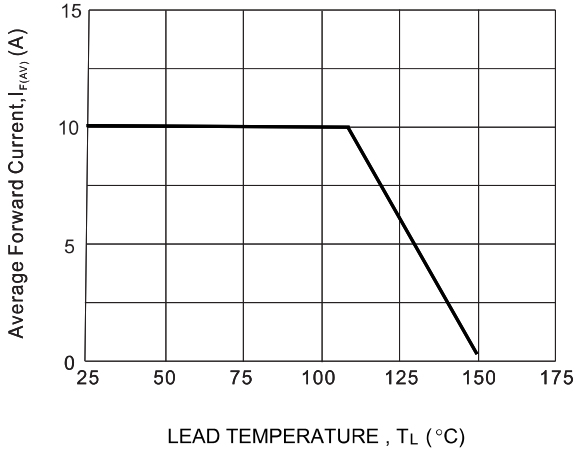

Fig. 2 Typical Forward Characteristics (per leg)

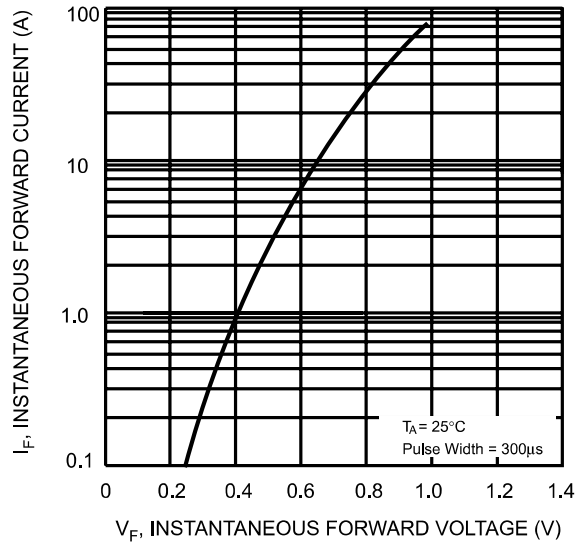

Fig. 3 Maximum Peak Forward Surge Current (per leg)

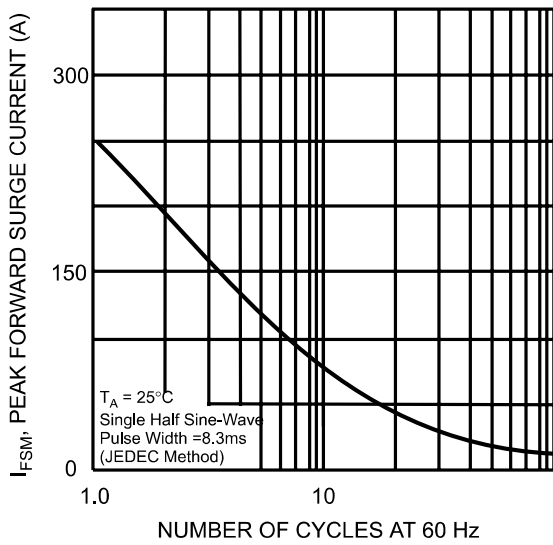
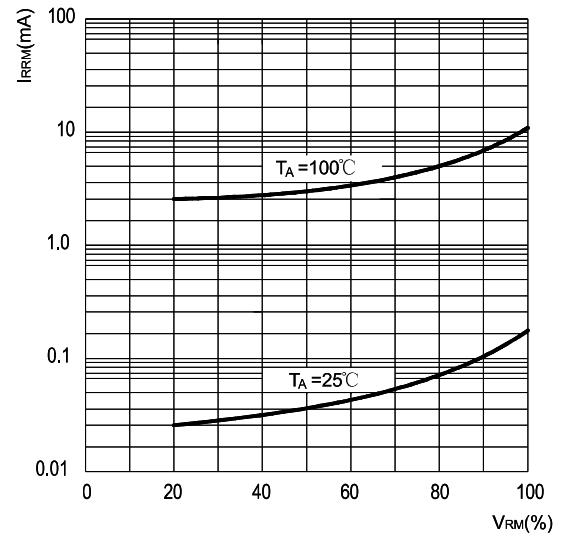

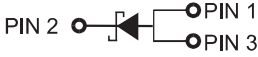

Fig4: Typical Reverse Characteristics



Pinning information

Pin	Simplified outline	Symbol
Pin2 cathode Pin1 anode Pin3 anode		

Marking

Type number	Marking code
SU10100-T	SU10100

Suggested solder pad layout

TO-277B

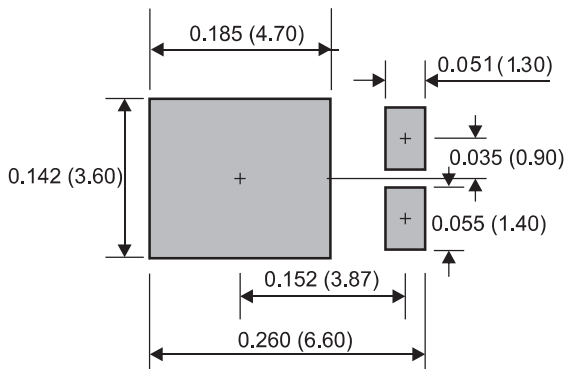

Dimensions in inches and (millimeters)