

### Features

- ◆ The plastic package carries Underwriters Laboratory Flammability Classification 94V-0
- ◆ For surface mounted applications
- ◆ Metal silicon junction, majority carrier conduction
- ◆ Low power loss, high efficiency
- ◆ Built-in strain relief, ideal for automated placement
- ◆ High forward surge current capability
- ◆ High temperature soldering guaranteed: 250°C/10 seconds at terminals
- ◆ Compliant to RoHS Directive 2011/65/EU
- ◆ Compliant to Halogen-free

### Package outline

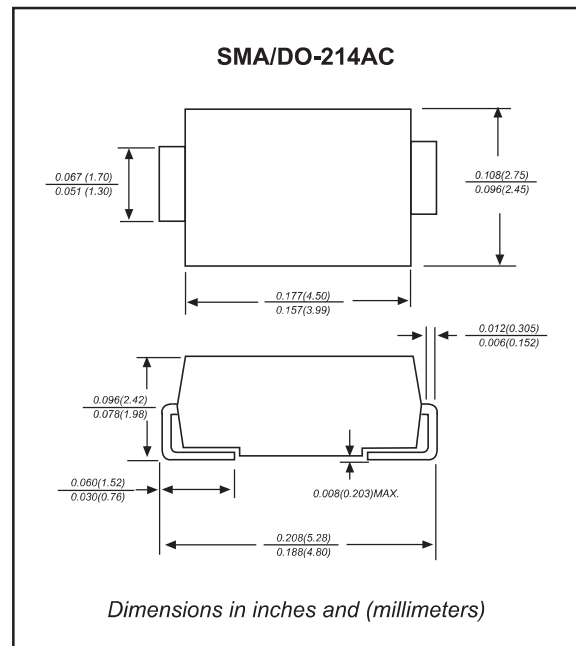

### Mechanical data

- ◆ **Case:** JEDEC DO-214AC molded plastic body
- ◆ **Terminals:** Solder plated, solderable per MIL-STD-750, Method 2026
- ◆ **Polarity:** Color band denotes cathode end
- ◆ **Mounting Position:** Any

### Maximum ratings and Electrical Characteristics (AT $T_A=25^\circ\text{C}$ unless otherwise noted)

PARAMETER	CONDITIONS		Symbol	MIN.	TYP.	MAX.	UNIT
Forward rectified current	See Fig.1		$I_O$			1.0	A
Forward surge current	8.3ms single half sine-wave (JEDEC methode)		$I_{FSM}$			30	A
Reverse current	$T_A = 25^\circ\text{C}$	$V_R = 20\text{V} - 60\text{V}$	$I_R$			0.5	mA
		$V_R = 80\text{V} - 200\text{V}$				0.1	
Reverse current	$T_A = 100^\circ\text{C}$	$V_R = 20\text{V} - 60\text{V}$	$I_R$			10	mA
		$V_R = 80\text{V} - 200\text{V}$				5	
Thermal resistance	Junction to ambient NOTE 1		$R_{\theta JA}$		88		$^\circ\text{C}/\text{W}$
Diode junction capacitance	$f=1\text{MHz}$ and applied 4V DC reverse voltage		$C_J$		110		pF
Storage temperature			$T_{STG}$	-65		+150	$^\circ\text{C}$

**Note:** 1.P.C.B. mounted with 0.2x0.2"(5.0x5.0mm) copper pad areas

SYMBOLS	$V_{RM}^{*1}$ (V)	$V_{RMS}^{*2}$ (V)	$V_R^{*3}$ (V)	$V_F^{*4}$ (V)	Operating temperature $T_J$ , ( $^\circ\text{C}$ )
SS12-A	20	14	20	0.55	-55 to +125
SS13-A	30	21	30		
SS14-A	40	28	40		
SS15-A	50	35	50	0.70	-55 to +150
SS16-A	60	42	60		
SS18-A	80	56	80	0.85	
SS110-A	100	70	100		
SS115-A	150	105	150	0.92	
SS120-A	200	140	200		

\*1 Repetitive peak reverse voltage

\*2 RMS voltage

\*3 Continuous reverse voltage

\*4 Maximum forward voltage@ $I_F=1.0\text{A}$

### Rating and characteristic curves

AVERAGE FORWARD RECTIFIED CURRENT, AMPERES

FIG. 1- FORWARD CURRENT DERATING CURVE

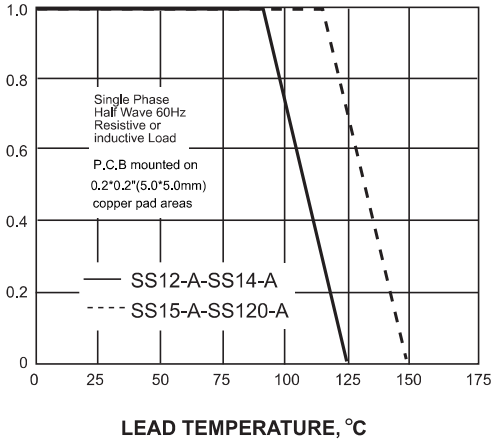

PEAK FORWARD SURGE CURRENT, AMPERES

FIG. 2-MAXIMUM NON-REPETITIVE PEAK FORWARD SURGE CURRENT

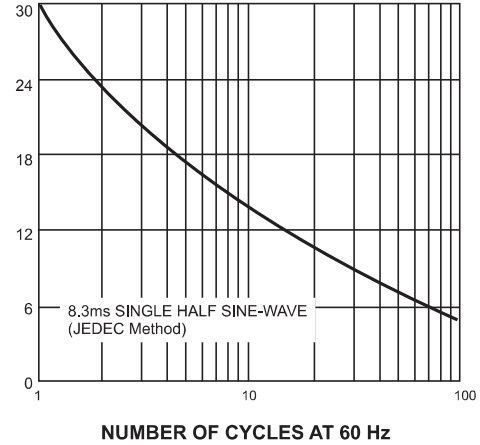

INSTANTANEOUS FORWARD CURRENT, AMPERES

FIG. 3-TYPICAL INSTANTANEOUS FORWARD CHARACTERISTICS

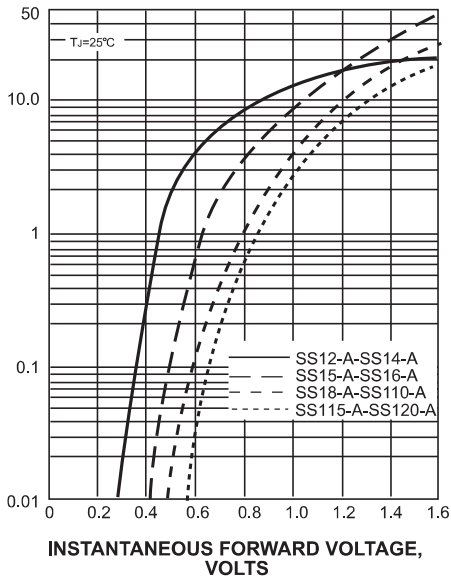

INSTANTANEOUS REVERSE CURRENT, MILLIAMPERES

FIG. 4-TYPICAL REVERSE CHARACTERISTICS

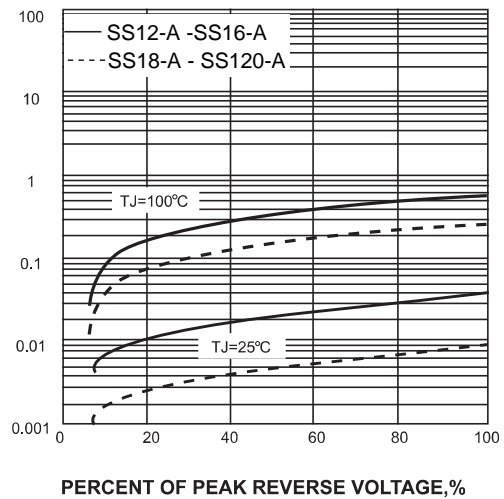

JUNCTION CAPACITANCE, pF

FIG. 5-TYPICAL JUNCTION CAPACITANCE

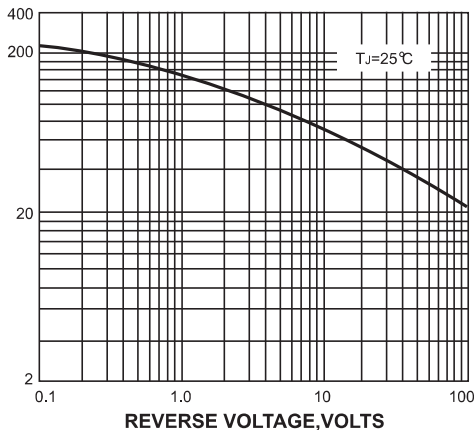

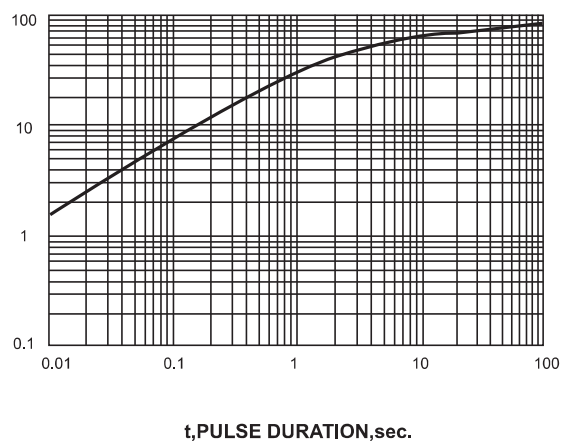

TRANSIENT THERMAL IMPEDANCE, °C/W

FIG. 6-TYPICAL TRANSIENT THERMAL IMPEDANCE



### Pinning information

Pin	Simplified outline	Symbol
Pin1 cathode Pin2 anode		

### Marking

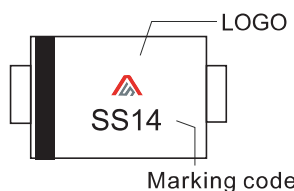
Type number	Marking code	Example
SS12-A	SS12	
SS13-A	SS13	
SS14-A	SS14	
SS15-A	SS15	
SS16-A	SS16	
SS18-A	SS18	
SS110-A	SS110	
SS115-A	SS115	
SS120-A	SS120	

### Suggested solder pad layout

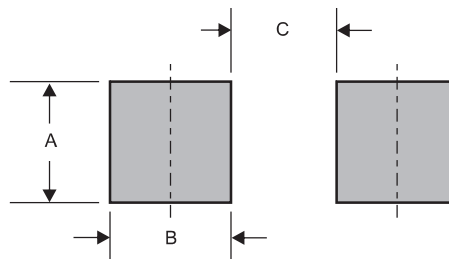

Dimensions in inches and (millimeters)

PACKAGE	A	B	C
SMA	0.110 (2.80)	0.063 (1.60)	0.087 (2.20)