

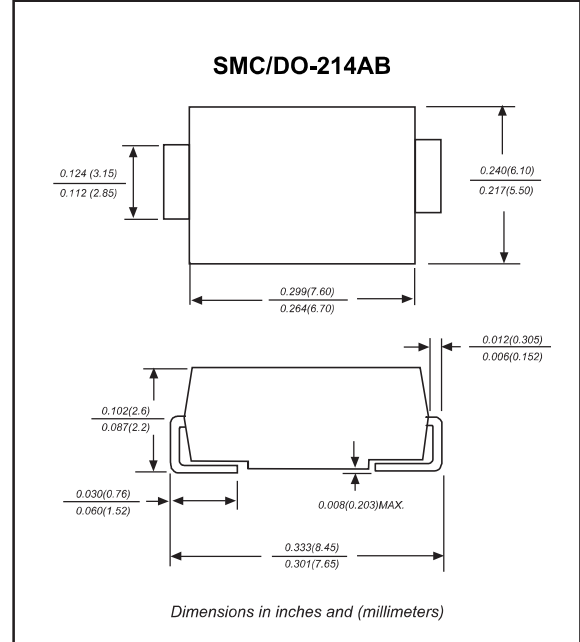
### Features

- 1500W peak pulse power capability with a 10/1000 us waveform, repetition rate (duty cycle): 0.01%.
- Excellent clamping capability.
- Low incremental surge resistance.
- Fast response time from 0V to VBR, typically less than 1 ps for uni-directional & 5 ns for bi-directional types.
- Glass passivated chip junction.
- Lead-free parts meet RoHS requirements.
- Compliant to Halogen-free
- Suffix "-Q1" for AEC-Q101.

### Mechanical data

- Epoxy:UL94-V0 rated flame retardant
- Case : Molded plastic, DO-214AB / SMC
- Terminals : Solder plated, solderable per MIL-STD-750, Method 2026
- Polarity : Indicated by cathode band
- Mounting Position : Any

### Package outline



### Maximum ratings (AT $T_A=25^\circ\text{C}$ unless otherwise noted)

PARAMETER	CONDITIONS	Symbol	Value	UNIT
Peak Power Dissipation	with a 10/1000 us waveform, Note 1, 2 & Fig. 1	$P_{PPM}$	1500	W
Peak Pulse current	with a 10/1000 us waveform	$I_{PPM}$	See Table	A
Steady State Power Dissipation	at $T_L=75^\circ\text{C}$ , Note 2	$P_{M(AV)}$	6.5	W
Peak Forward Surge Current	8.3ms Single Half Sine-Wave, Note 3	$I_{FSM}$	200	A
Maximum Instantaneous Forward Voltage	at 100A For Uni-Directional Types Only Note 4	$V_F$	3.5/5.0	V
Operating junction temperature range		$T_J$	-55 to +150	$^\circ\text{C}$
Storage temperature range		$T_{STG}$	-55 to +150	$^\circ\text{C}$

Note 1. Non-repetitive current pulse, per Fig. 3 and derated above  $T_A=25^\circ\text{C}$  per Fig. 2

2. Mounted on copper pad area of 0.31 x 0.31" (8.0 x 8.0 mm) per Fig 5

3. Measured on 8.3 ms single half sine-wave or equivalent square wave, duty cycle=4 pulses per minute maximum

4.  $V_F < 3.5\text{V}$  for  $V_{BR} < 200\text{V}$  and  $V_F < 5.0\text{V}$  for  $V_{BR} > 201\text{V}$

### Electrical characteristics (at $T_A=25^\circ\text{C}$ unless otherwise noted)

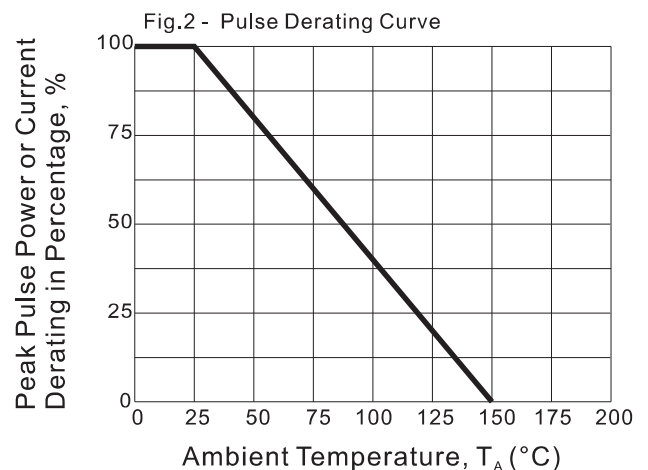
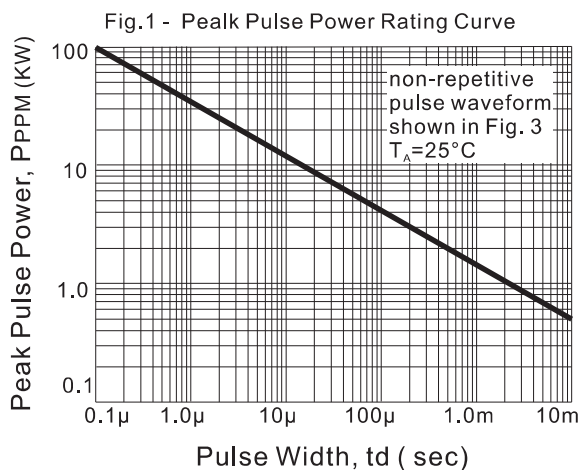
Part No. (UNI)	Part No. (BI)	Reverse Stand-off Voltage	Breakdown Voltage @ $I_T$		Test Current	Maximum Clamping Voltage @ $I_{PP}$		Maximum Reverse Leakage Current	Marking Code	
		$V_{RWM}$	$V_{BR\ Min}$	$V_{BR\ Max}$	$I_T$	$V_c$	$I_{PP}$	$I_R@V_{RWM}$		
		Volts	Volts	Volts	mA	Volts	A	$\mu\text{A}$	UNI	BI
SMCJ5.0A-Q1	SMCJ5.0CA-Q1	5.0	6.40	7.00	10	9.2	163.0	800	GDE	BDE
SMCJ6.0A-Q1	SMCJ6.0CA-Q1	6.0	6.67	7.37	10	10.3	145.6	800	GDG	BDG
SMCJ6.5A-Q1	SMCJ6.5CA-Q1	6.5	7.22	7.98	10	11.2	133.9	500	GDK	BDK
SMCJ7.0A-Q1	SMCJ7.0CA-Q1	7.0	7.78	8.60	10	12.0	125.0	200	GDM	BDM
SMCJ7.5A-Q1	SMCJ7.5CA-Q1	7.5	8.33	9.21	1.0	12.9	116.3	100	GDP	BDP
SMCJ8.0A-Q1	SMCJ8.0CA-Q1	8.0	8.89	9.83	1.0	13.6	110.3	50	GDR	BDR
SMCJ8.5A-Q1	SMCJ8.5CA-Q1	8.5	9.44	10.4	1.0	14.4	104.2	20	GDT	BDT
SMCJ9.0A-Q1	SMCJ9.0CA-Q1	9.0	10.0	11.1	1.0	15.4	97.4	10	GDV	BDV
SMCJ10A-Q1	SMCJ10CA-Q1	10	11.1	12.3	1.0	17.0	88.2	5	GDX	BDX
SMCJ11A-Q1	SMCJ11CA-Q1	11	12.2	13.5	1.0	18.2	82.4	1	GDZ	BDZ
SMCJ12A-Q1	SMCJ12CA-Q1	12	13.3	14.7	1.0	19.9	75.3	1	GEE	BEE
SMCJ13A-Q1	SMCJ13CA-Q1	13	14.4	15.9	1.0	21.5	69.7	1	GEG	BEG
SMCJ14A-Q1	SMCJ14CA-Q1	14	15.6	17.2	1.0	23.2	64.7	1	GEK	BEK
SMCJ15A-Q1	SMCJ15CA-Q1	15	16.7	18.5	1.0	24.4	61.5	1	GEM	BEM
SMCJ16A-Q1	SMCJ16CA-Q1	16	17.8	19.7	1.0	26.0	57.7	1	GEP	BEP
SMCJ17A-Q1	SMCJ17CA-Q1	17	18.9	20.9	1.0	27.6	54.4	1	GER	BER
SMCJ18A-Q1	SMCJ18CA-Q1	18	20.0	22.1	1.0	29.2	51.4	1	GET	BET
SMCJ20A-Q1	SMCJ20CA-Q1	20	22.2	24.5	1.0	32.4	46.3	1	GEV	BEV
SMCJ22A-Q1	SMCJ22CA-Q1	22	24.4	26.9	1.0	35.5	42.2	1	GEX	BEX
SMCJ24A-Q1	SMCJ24CA-Q1	24	26.7	29.5	1.0	38.9	38.6	1	GEZ	BEZ
SMCJ26A-Q1	SMCJ26CA-Q1	26	28.9	31.9	1.0	42.1	35.6	1	GFE	BFE
SMCJ28A-Q1	SMCJ28CA-Q1	28	31.1	34.4	1.0	45.4	33.0	1	GFG	BFG
SMCJ30A-Q1	SMCJ30CA-Q1	30	33.3	36.8	1.0	48.4	31.0	1	GFK	BFK
SMCJ33A-Q1	SMCJ33CA-Q1	33	36.7	40.6	1.0	53.3	28.1	1	GFM	BFM
SMCJ36A-Q1	SMCJ36CA-Q1	36	40.0	44.2	1.0	58.1	25.8	1	GFP	BFP
SMCJ40A-Q1	SMCJ40CA-Q1	40	44.4	49.1	1.0	64.5	23.2	1	GFR	BFR
SMCJ43A-Q1	SMCJ43CA-Q1	43	47.8	52.8	1.0	69.4	21.6	1	GFT	BFT
SMCJ45A-Q1	SMCJ45CA-Q1	45	50.0	55.3	1.0	72.7	20.6	1	GFV	BFV
SMCJ48A-Q1	SMCJ48CA-Q1	48	53.3	58.9	1.0	77.4	19.4	1	GFX	BFX
SMCJ51A-Q1	SMCJ51CA-Q1	51	56.7	62.7	1.0	82.4	18.2	1	GFZ	BFZ
SMCJ54A-Q1	SMCJ54CA-Q1	54	60.0	66.3	1.0	87.1	17.2	1	GGE	BGE
SMCJ58A-Q1	SMCJ58CA-Q1	58	64.4	71.2	1.0	93.6	16.0	1	GGG	BGG
SMCJ60A-Q1	SMCJ60CA-Q1	60	66.7	73.7	1.0	96.8	15.5	1	GGK	BGK
SMCJ64A-Q1	SMCJ64CA-Q1	64	71.1	78.6	1.0	103.0	14.6	1	GGM	BGM
SMCJ70A-Q1	SMCJ70CA-Q1	70	77.8	86.0	1.0	113.0	13.3	1	GGP	BGP
SMCJ75A-Q1	SMCJ75CA-Q1	75	83.3	92.1	1.0	121.0	12.4	1	GGR	BGR
SMCJ78A-Q1	SMCJ78CA-Q1	78	86.7	95.8	1.0	126.0	11.9	1	GGT	BGT
SMCJ85A-Q1	SMCJ85CA-Q1	85	94.4	104	1.0	137.0	11.0	1	GGV	BGV

### Electrical characteristics (at $T_A$ 25 C unless otherwise noted)

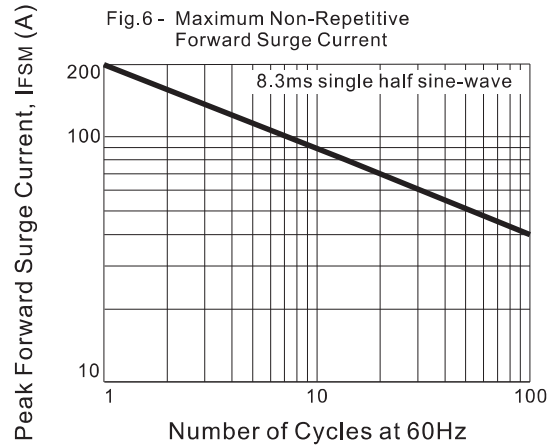
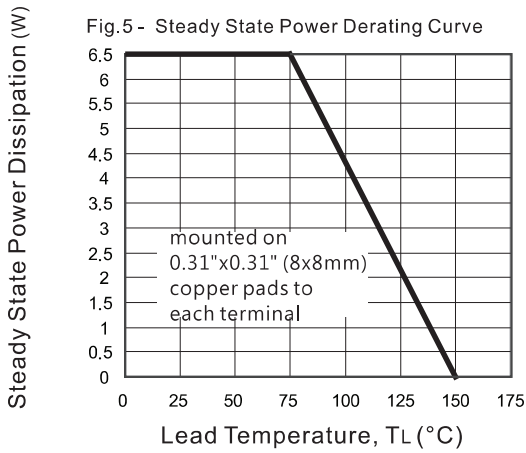
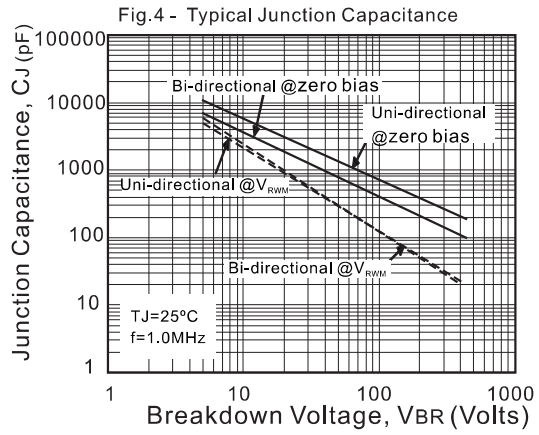
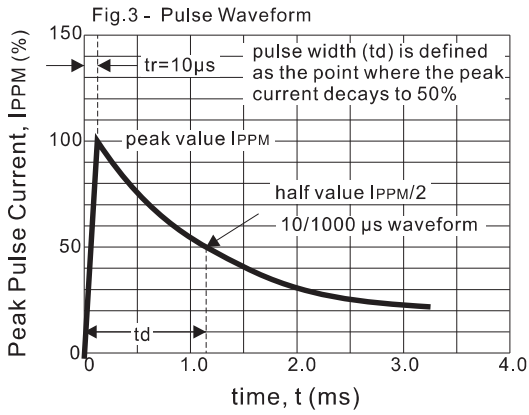
Part No. (UNI)	Part No. (BI)	Reverse Stand-off Voltage	Breakdown Voltage @ $I_T$		Test Current	Maximum Clamping Voltage @ $I_{PP}$		Maximum Reverse Leakage Current	Marking Code	
		$V_{RWM}$	$V_{BR Min}$	$V_{BR Max}$	$I_T$	$V_C$	$I_{PP}$	$I_R @ V_{RWM}$		
		Volts	Volts	Volts	mA	Volts	A	$\mu A$	UNI	BI
SMCJ90A-Q1	SMCJ90CA-Q1	90	100	111	1.0	146.0	10.3	1	GGX	BGX
SMCJ100A-Q1	SMCJ100CA-Q1	100	111	123	1.0	162.0	9.3	1	GGZ	BGZ
SMCJ110A-Q1	SMCJ110CA-Q1	110	122	135	1.0	177.0	8.4	1	GHE	BHE
SMCJ120A-Q1	SMCJ120CA-Q1	120	133	147	1.0	193.0	7.8	1	GHG	BHG
SMCJ130A-Q1	SMCJ130CA-Q1	130	144	159	1.0	209.0	7.2	1	GHK	BHK
SMCJ150A-Q1	SMCJ150CA-Q1	150	167	185	1.0	243.0	6.2	1	GHM	BHM
SMCJ160A-Q1	SMCJ160CA-Q1	160	178	197	1.0	259.0	5.8	1	GHP	BHP
SMCJ170A-Q1	SMCJ170CA-Q1	170	189	209	1.0	275.0	5.5	1	GHR	BHR
SMCJ180A-Q1	SMCJ180CA-Q1	180	201	222	1.0	292.0	5.1	1	GHT	BHT
SMCJ200A-Q1	SMCJ200CA-Q1	200	224	247	1.0	324.0	4.6	1	GHV	BHV
SMCJ220A-Q1	SMCJ220CA-Q1	220	246	272	1.0	356.0	4.2	1	GHX	BHX
SMCJ250A-Q1	SMCJ250CA-Q1	250	279	309	1.0	405.0	3.7	1	GHZ	BHZ
SMCJ300A-Q1	SMCJ300CA-Q1	300	335	371	1.0	486.0	3.1	1	GJE	BJE
SMCJ350A-Q1	SMCJ350CA-Q1	350	391	432	1.0	567.0	2.6	1	GJG	BJG
SMCJ400A-Q1	SMCJ400CA-Q1	400	447	494	1.0	648.0	2.3	1	GJK	BJK
SMCJ440A-Q1	SMCJ440CA-Q1	440	492	543	1.0	713.0	2.1	1	GJM	BJM

- Note 1.  $V_{BR}$  measured after  $I_T$  applied for 300us,  $I_T$ =square wave pulse or equivalent  
 2. Surge current waveform per Fig. 3 and derated per Fig. 2  
 3. For bi-directional types having  $V_{RWM}$  of 10 volts and less, the  $I_R$  limit is doubled  
 4. Suffix 'C' denotes bi-directional devices, Suffix 'A' denotes 5% tolerance devices, no suffix denotes 10% tolerance devices.  
 5. All terms and symbols are consistent with ANS/IEEE C62.35  
 6. Transient Voltage Suppressors (TVS) are devices used to protect vulnerable circuits from electrical overstress such as that caused by electrostatic discharge, inductive load switching and induced lightning. Within the TVS, damaging voltage spikes are limited by clamping or avalanche action of a rugged silicon pn junction which reduces the amplitude of the transient to a nondestructive level. See Fig. 7 & Fig. 8

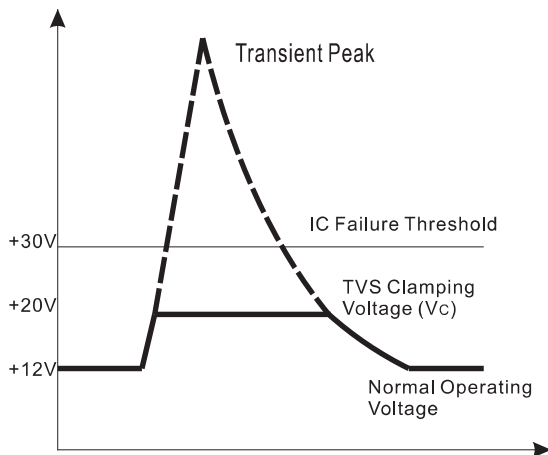
### Rating and characteristic curves (SMCJ SERIES)



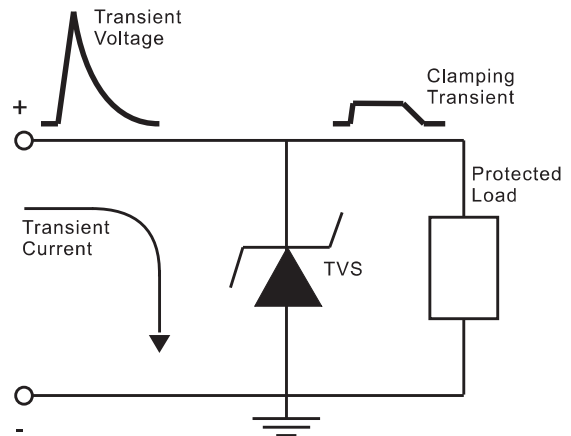
## Rating and characteristic curves ( SMCJ-Q1 Series )



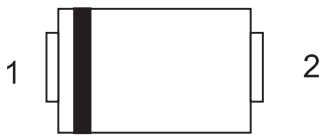



**Fig. 7 - Transients of several thousand volts can be clamped to a safe level by the TVS**





**Fig. 8 - Transient current is diverted to ground thru TVS; the voltage seen by the protected load is limited to the clamping voltage level**



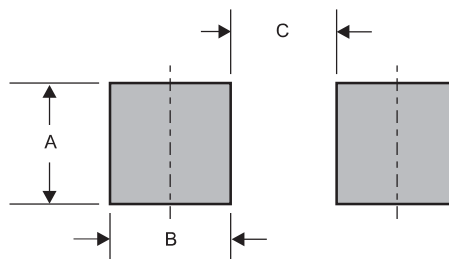
### Pinning information

Pin	Simplified outline	Symbol
Uni-Directional Pin1 cathode Pin2 anode		
Bi-Directional		

### Marking

Type number	Example
Uni-Directional	 <p>Cathode band</p> <p>Marking code (see page 2 to page 3)</p>
Bi-Directional	 <p>Marking code (see page 2 to page 3)</p>

### Suggested solder pad layout



Dimensions in inches and (millimeters)

PACKAGE	A	B	C
SMC	0.132 (3.30)	0.100 (2.50)	0.176 (4.40)