

Features

- Batch process design, excellent power dissipation offers better reverse leakage current and thermal resistance.
- Low profile surface mounted application in order to optimize board space.
- Low power loss, high efficiency.
- High current capability, low forward voltage drop.
- High surge capability.
- Guardring for overvoltage protection.
- Ultra high-speed switching.
- Silicon epitaxial planar chip, metal silicon junction.
- Lead-free parts meet environmental standards of MIL-STD-19500 /228
- Compliant to Halogen-free
- Suffix "-Q1" for AEC-Q101

Mechanical data

- Epoxy:UL94-V0 rated flame retardant
- Case : TO-277B , molded Plastic
- Terminals:Solderable per MIL-STD-750,Method 2026
- Marking:Pages 3

Package outline

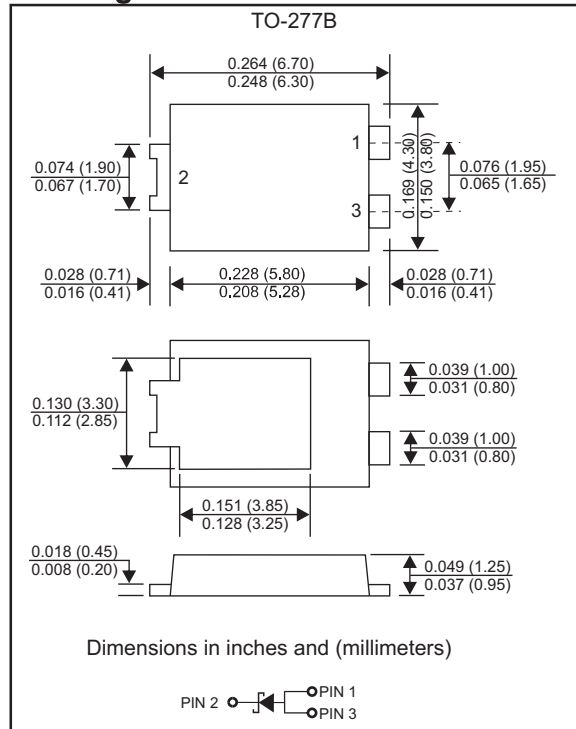

Maximum ratings and Electrical Characteristics (AT $T_A=25^\circ\text{C}$ unless otherwise noted)

PARAMETER	CONDITIONS	Symbol	MIN.	TYP.	MAX.	UNIT
Forward rectified current	See Fig.1	I_O			5.0	A
Forward surge current	8.3ms single half sine-wave (JEDEC methode)	I_{FSM}			120	A
Reverse current	$V_R = V_{RRM} T_J = 25^\circ\text{C}$	I_R			0.5	mA
	$V_R = V_{RRM} T_J = 100^\circ\text{C}$				10	
Typical Thermal resistance	Junction to ambient	$R_{\theta JA}$		80		$^\circ\text{C}/\text{W}$
	Junction to lead	$R_{\theta JL}$		15		$^\circ\text{C}/\text{W}$
Storage temperature		T_{STG}	-65		+175	$^\circ\text{C}$

SYMBOLS	V_{RRM}^{*1} (V)	V_{RMS}^{*2} (V)	V_R^{*3} (V)	V_F^{*4} (V)	Operating temperature $T_{J,}$ ($^\circ\text{C}$)
SL5100-T-Q1	100	70	100	0.80	-55 to +150

*1 Repetitive peak reverse voltage

*2 RMS voltage

*3 Continuous reverse voltage

*4 Maximum forward voltage@ $I_F=5.0\text{A}$

Rating and characteristic curves

FIG.1-TYPICAL FORWARD CURRENT DERATING CURVE

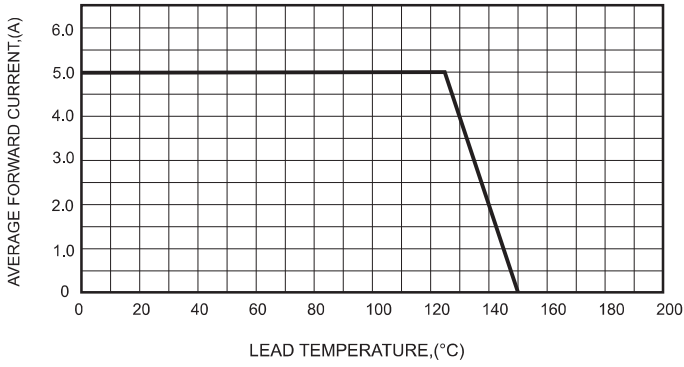

FIG.2-TYPICAL FORWARD CHARACTERISTICS

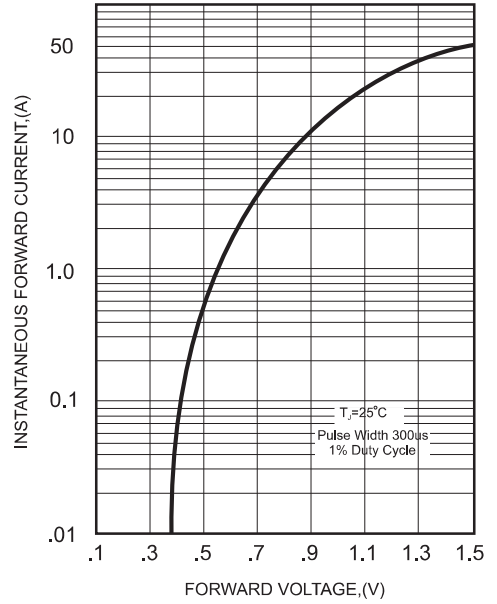

FIG.3-MAXIMUM NON-REPETITIVE FORWARD SURGE CURRENT

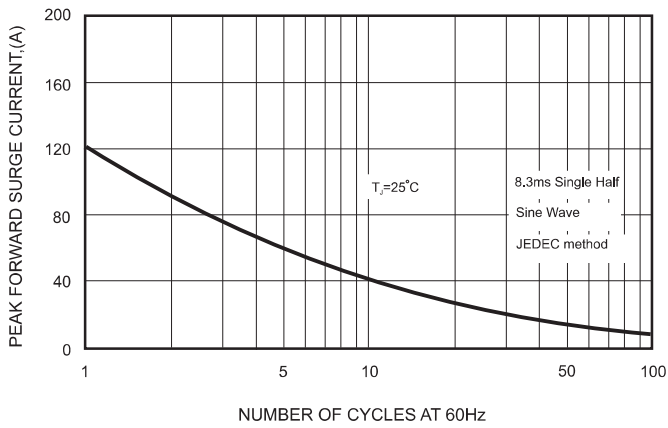
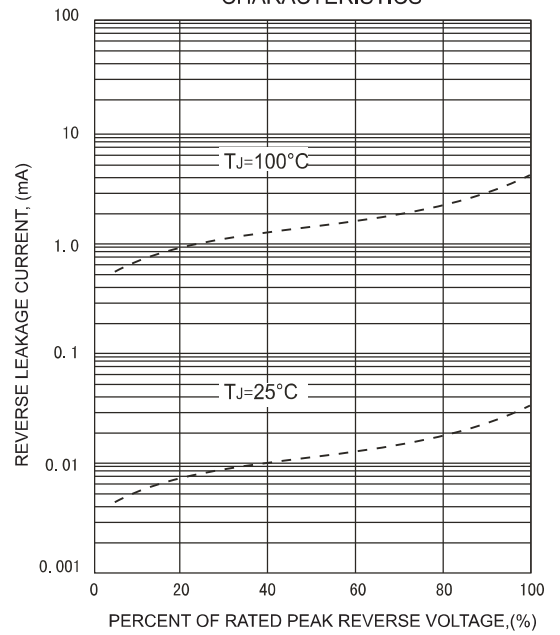

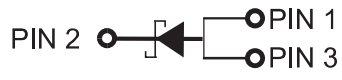

FIG.4 - TYPICAL REVERSE CHARACTERISTICS



Pinning information

Pin	Simplified outline	Symbol
PIN 1 anode PIN 3 anode PIN 2 cathode		

Marking

Type number	Marking code
SL5100-T-Q1	SL05100

Suggested solder pad layout

TO-277B

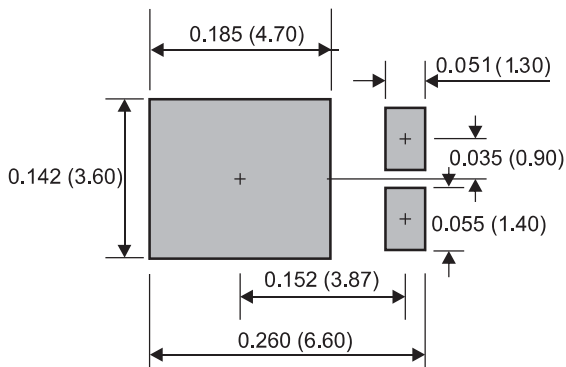

Dimensions in inches and (millimeters)