

### Features

- ▶ The plastic package carries Underwriters Laboratory Flammability Classification 94V-0
- ▶ For surface mounted applications
- ▶ Metal silicon junction, majority carrier conduction
- ▶ Low power loss, high efficiency
- ▶ Built-in strain relief, ideal for automated placement
- ▶ High forward surge current capability
- ▶ High temperature soldering guaranteed: 250°C/10 seconds at terminals
- ▶ Compliant to RoHS Directive 2011/65/EU
- ▶ Compliant to Halogen-free

### Mechanical data

- ▶ **Case:** JEDEC DO-214AC molded plastic body
- ▶ **Terminals:** Solder plated, solderable per MIL-STD-750, Method 2026
- ▶ **Polarity:** Color band denotes cathode end
- ▶ **Mounting Position:** Any

### Package outline

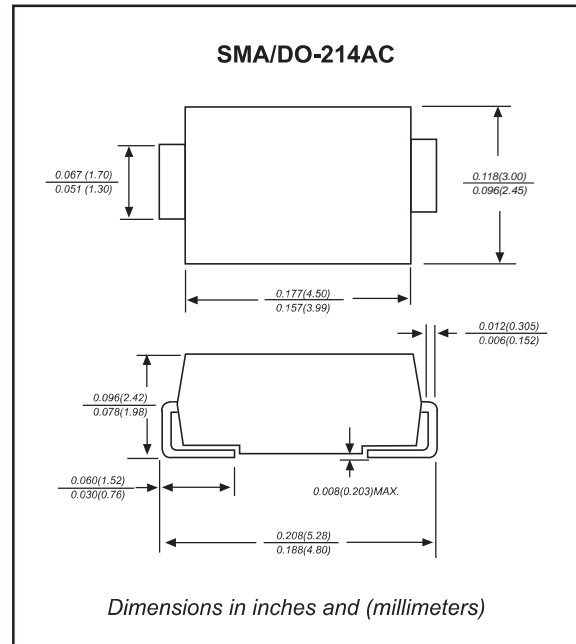

### Maximum ratings and Electrical Characteristics (AT $T_A=25^\circ\text{C}$ unless otherwise noted)

PARAMETER	CONDITIONS	Symbol	MIN.	TYP.	MAX.	UNIT
Forward rectified current	See Fig.2	$I_O$			3.0	A
Forward surge current	8.3ms single half sine-wave (JEDEC methode)	$I_{FSM}$			80	A
Reverse current	$V_R = V_{RRM} \quad T_A = 25^\circ\text{C}$	$I_R$			0.5	mA
	$V_R = V_{RRM} \quad T_A = 100^\circ\text{C}$				10	
Thermal resistance (1)	Junction to Ambient	$R_{\theta JA}$		70		$^\circ\text{C/W}$
	Junction to Case	$R_{\theta JC}$		25		
	Junction to Lead	$R_{\theta JL}$		30		
Diode junction capacitance	f=1MHz and applied 4V DC reverse voltage	$C_J$		500		pF
Storage temperature		$T_{STG}$	-65		+150	$^\circ\text{C}$

**Note:** (1) Device mounted on p.c.b. with 10 mm x 20 mm x 0.1 mm copper pad area.

SYMBOLS	$V_{RRM}^{*1}$ (V)	$V_{RMS}^{*2}$ (V)	$V_R^{*3}$ (V)	$V_F^{*4}$ (V)	Operating temperature $T_J$ ( $^\circ\text{C}$ )
SL34-A	40	28	40	0.45	-55 to +125
SL345-A	45	32	45		
SL35-A	50	35	50	0.55	-55 to +150
SL36-A	60	42	60		
SL38-A	80	56	80	0.75	
SL310-A	100	70	100		
SL315-A	150	105	150	0.85	
SL320-A	200	140	200		

\*1 Repetitive peak reverse voltage

\*2 RMS voltage



\*3 Continuous reverse voltage

\*4 Maximum forward voltage@ $I_F=3.0\text{A}$

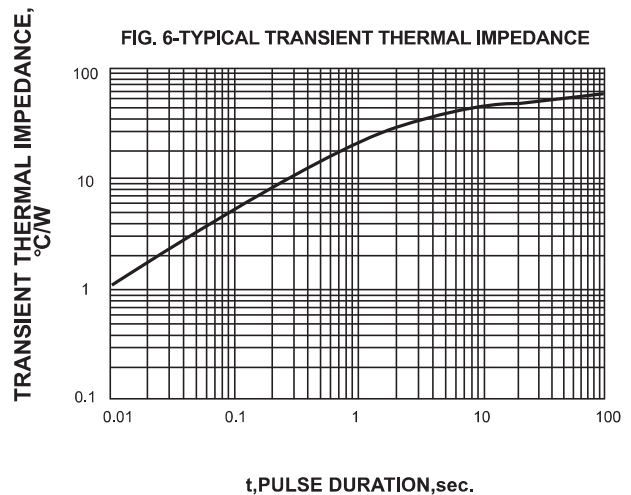
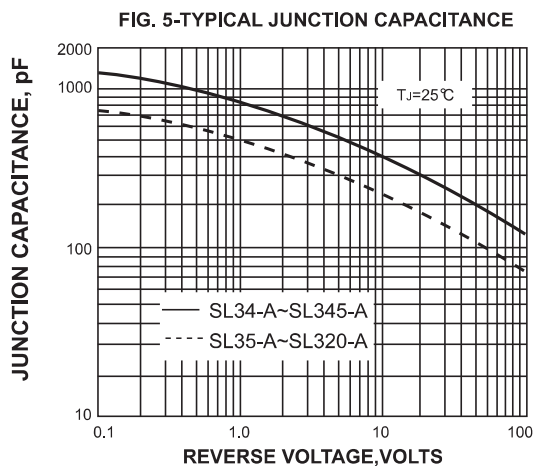
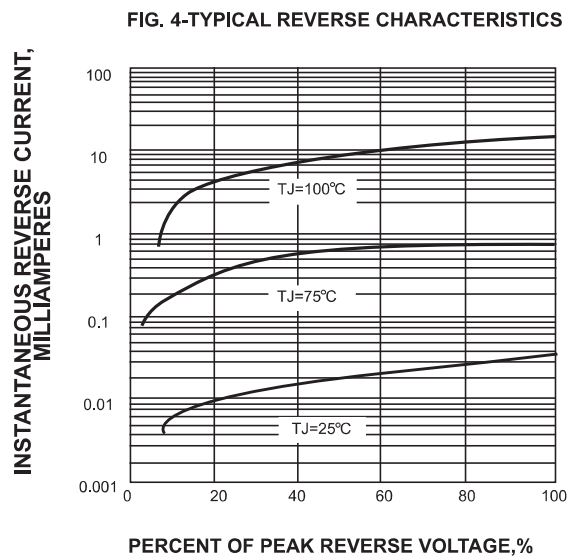
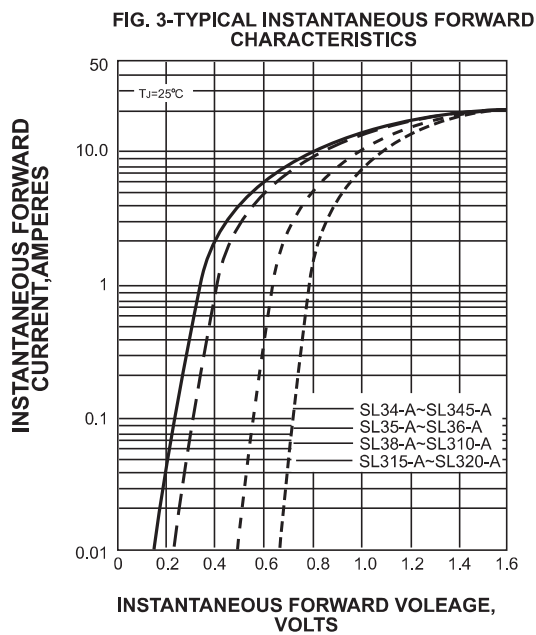
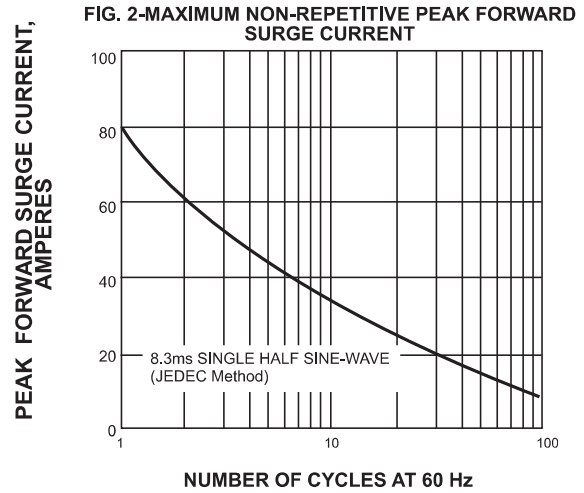
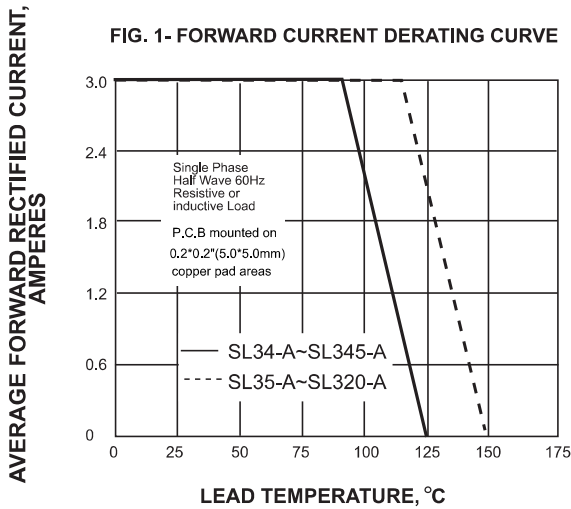
### Rating and characteristic curves



### Pinning information

Pin	Simplified outline	Symbol
Pin1 cathode Pin2 anode		

### Marking

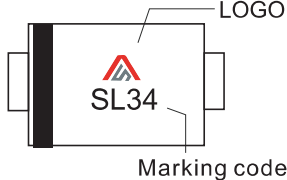
Type number	Marking code	Example
SL34-A	SL34	
SL345-A	SL345	
SL35-A	SL35	
SL36-A	SL36	
SL38-A	SL38	
SL310-A	SL310	
SL315-A	SL315	
SL320-A	SL320	

### Suggested solder pad layout

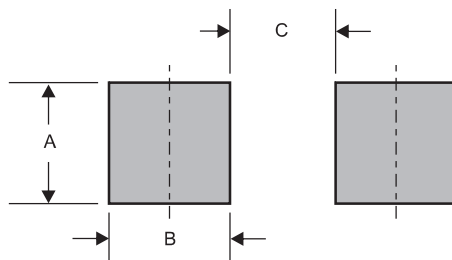

Dimensions in inches and (millimeters)

PACKAGE	A	B	C
SMA	0.110 (2.80)	0.063 (1.60)	0.087 (2.20)