

Features

- ▶ The plastic package carries Underwriters Laboratory Flammability Classification 94V-0
- ▶ For surface mounted applications
- ▶ Metal silicon junction, majority carrier conduction
- ▶ Low power loss, high efficiency
- ▶ Built-in strain relief, ideal for automated placement
- ▶ High forward surge current capability
- ▶ High temperature soldering guaranteed: 250°C/10 seconds at terminals
- ▶ Compliant to RoHS Directive 2011/65/EU
- ▶ Compliant to Halogen-free
- ▶ Suffix "-Q1" for AEC-Q101

Mechanical data

- ▶ **Case:** JEDEC DO-214AC molded plastic body
- ▶ **Terminals:** Solder plated, solderable per MIL-STD-750, Method 2026
- ▶ **Polarity:** Color band denotes cathode end
- ▶ **Mounting Position:** Any

Package outline

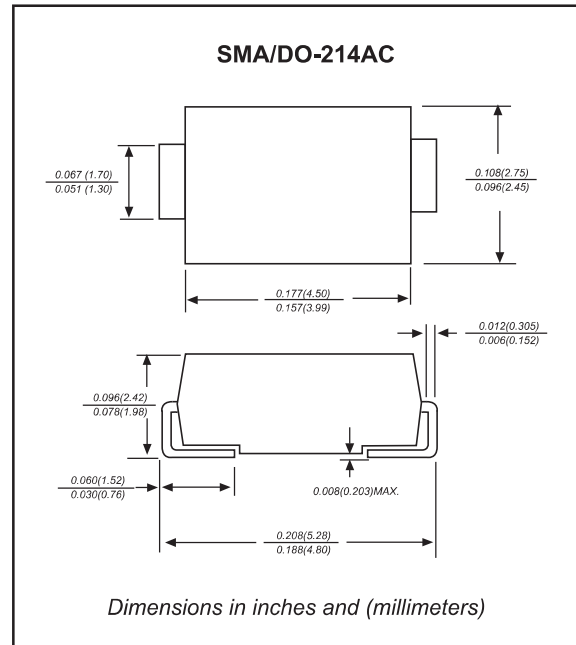

Maximum ratings and Electrical Characteristics (AT $T_A=25^\circ\text{C}$ unless otherwise noted)

PARAMETER	CONDITIONS	Symbol	MIN.	TYP.	MAX.	UNIT
Forward rectified current	See Fig.1	I_O			1.0	A
Forward surge current	8.3ms single half sine-wave (JEDEC methode)	I_{FSM}			30	A
Reverse current	$V_R = V_{RRM} \quad T_A = 25^\circ\text{C}$	I_R			1.0	mA
	$V_R = V_{RRM} \quad T_A = 100^\circ\text{C}$				20	
Thermal resistance	Junction to ambient NOTE 1	$R_{\theta JA}$		88		$^\circ\text{C}/\text{W}$
Diode junction capacitance	f=1MHz and applied 4V DC reverse voltage	C_J		120		pF
Storage temperature		T_{STG}	-65		+150	$^\circ\text{C}$

Note: 1.P.C.B. mounted with 0.2x0.2"(5.0x5.0mm) copper pad areas

SYMBOLS	V_{RRM}^{*1} (V)	V_{RMS}^{*2} (V)	V_R^{*3} (V)	V_F^{*4} (V)	Operating temperature T_J , ($^\circ\text{C}$)
SL12-A-Q1	20	14	20	0.45	-55 to +125
SL13-A-Q1	30	21	30		
SL14-A-Q1	40	28	40		
SL15-A-Q1	50	35	50	0.55	-55 to +150
SL16-A-Q1	60	42	60		
SL18-A-Q1	80	56	80	0.75	
SL110-A-Q1	100	70	100		
SL115-A-Q1	150	105	150	0.85	
SL120-A-Q1	200	140	200		

*1 Repetitive peak reverse voltage

*2 RMS voltage

*3 Continuous reverse voltage

*4 Maximum forward voltage@ $I_F=1.0\text{A}$

Rating and characteristic curves

AVERAGE FORWARD RECTIFIED CURRENT, AMPERES

FIG. 1- FORWARD CURRENT DERATING CURVE

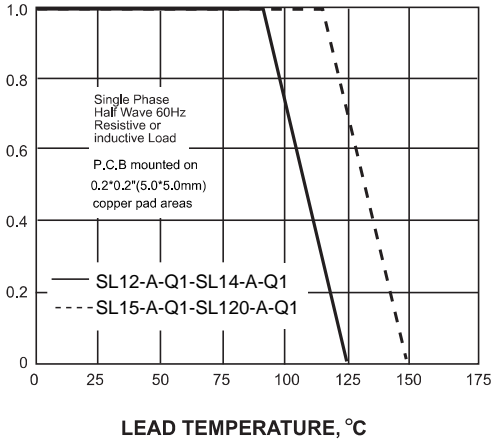

PEAK FORWARD SURGE CURRENT, AMPERES

FIG. 2-MAXIMUM NON-REPETITIVE PEAK FORWARD SURGE CURRENT

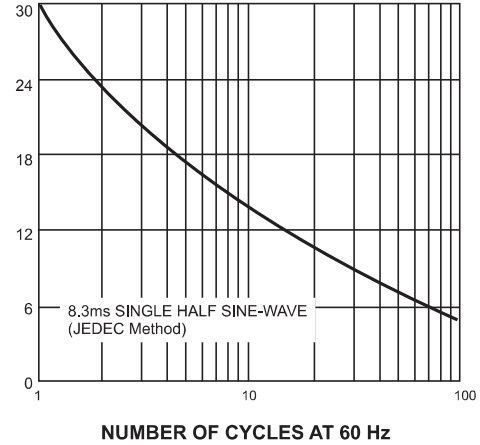

INSTANTANEOUS FORWARD CURRENT, AMPERES

FIG. 3-TYPICAL INSTANTANEOUS FORWARD CHARACTERISTICS

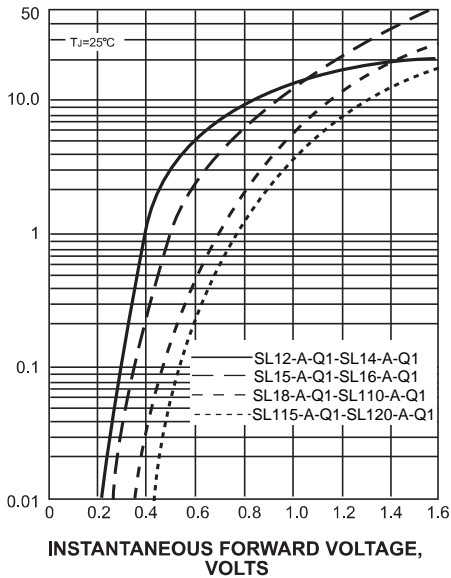

INSTANTANEOUS REVERSE CURRENT, MILLIAMPERES

FIG. 4-TYPICAL REVERSE CHARACTERISTICS

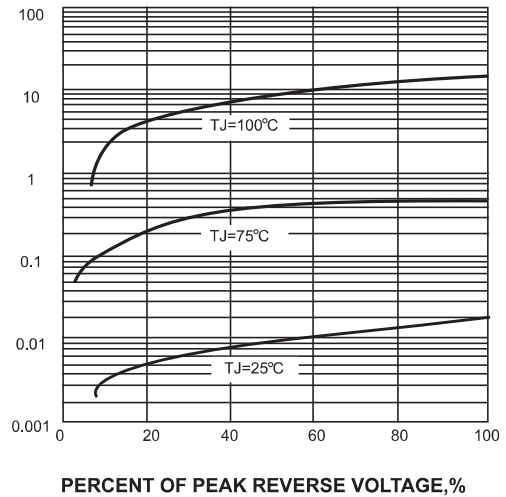

JUNCTION CAPACITANCE, pF

FIG. 5-TYPICAL JUNCTION CAPACITANCE

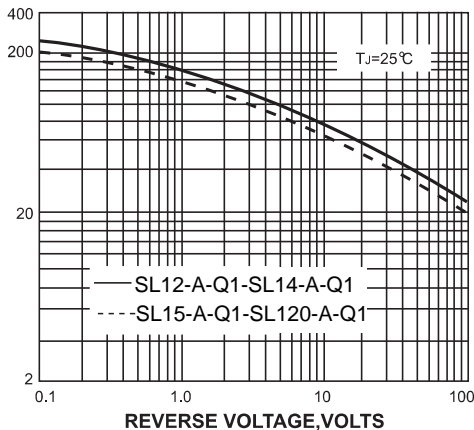

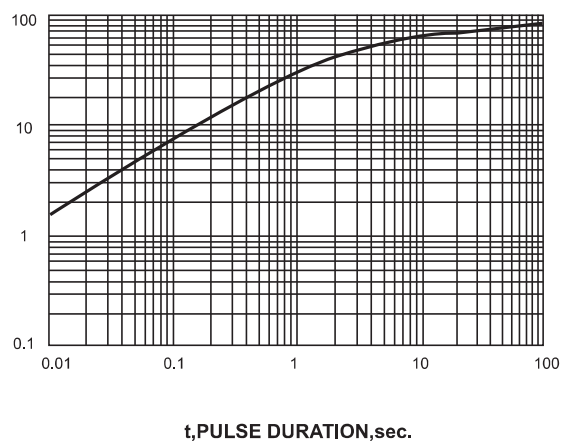

TRANSIENT THERMAL IMPEDANCE, °C/W

FIG. 6-TYPICAL TRANSIENT THERMAL IMPEDANCE



Pinning information

Pin	Simplified outline	Symbol
Pin1 cathode Pin2 anode		

Marking

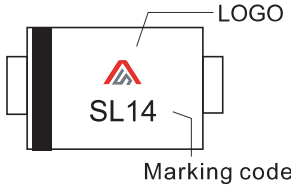
Type number	Marking code	Example
SL12-A-Q1	SL12	
SL13-A-Q1	SL13	
SL14-A-Q1	SL14	
SL15-A-Q1	SL15	
SL16-A-Q1	SL16	
SL18-A-Q1	SL18	
SL110-A-Q1	SL110	
SL115-A-Q1	SL115	
SL120-A-Q1	SL120	

Suggested solder pad layout

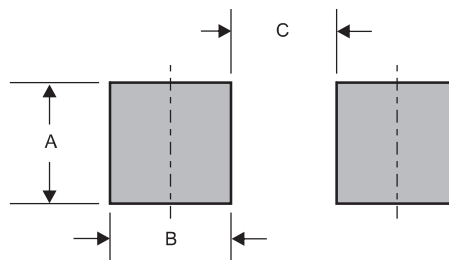

Dimensions in inches and (millimeters)

PACKAGE	A	B	C
SMA	0.110 (2.80)	0.063 (1.60)	0.087 (2.20)