

Features

- Ultra Low Forward Voltage Drop .
- Very low profile-typical height of 1.10mm
- Low Power Losses,High Efficiency Operation
- Low Thermal Resistance Package.
- High Operating Junction Temperature.
- Compliant to Halogen-free
- Suffix "-Q1" for AEC-Q101

Mechanical data

- Epoxy:UL94-V0 rated flame retardant
- Case : TO-277B , molded Plastic
- Terminals:Solderable per MIL-STD-750,Method 2026
- Marking:SL1045

Package outline

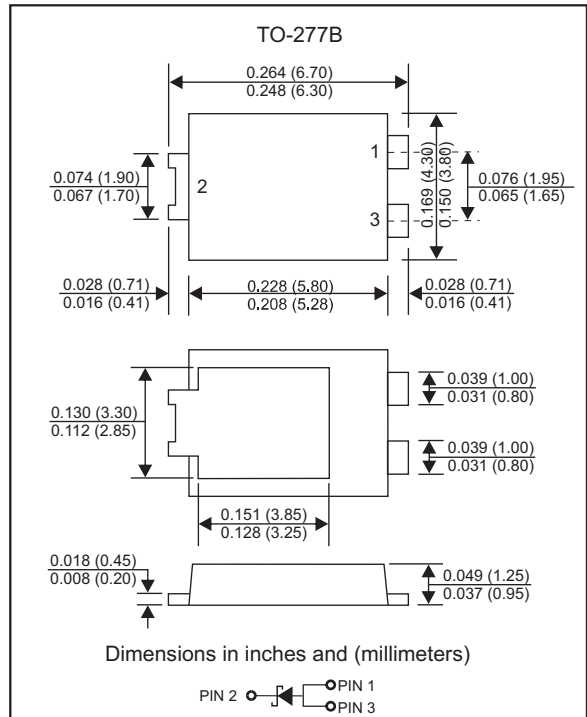

Maximum ratings (AT $T_A=25^\circ\text{C}$ unless otherwise noted)

Parameter	Symbol	SL1045-T-Q1	Unit
DC Blocking Voltage Working Peak Reverse Voltage Repetitive Peak Reverse Voltage	V_{DC} V_{RWM} V_{RRM}	45	V
RMS Reverse Voltage	V_{RMS}	31.5	V
Average Forward Rectified Current	$I_{F(AV)}$	10.0	A
Peak Forward Surge Current,8.3ms Half Sine-wave($T_A=25^\circ\text{C}$)	I_{FSM}	250	A
Operating junction temperature range	T_J	-55 to +150	$^\circ\text{C}$
Storage temperature range	T_{STG}	-55 to +150	$^\circ\text{C}$

Electrical Characteristics (AT $T_A=25^\circ\text{C}$ unless otherwise noted)

Parameter	Test Conditions	Symbol	MIN.	TYP.	MAX.	Unit
Reverse Breakdown Voltage	$I_R=0.5\text{mA}, T_J=25^\circ\text{C}$	V_B	45	-	-	V
Forward voltage	$I_F=8\text{A}, T_J=25^\circ\text{C}$	V_F	-	0.40	-	V
	$I_F=10\text{A}, T_J=25^\circ\text{C}$		-	0.42	0.45	
Reverse current	$V_R=45\text{V}, T_J=25^\circ\text{C}$	I_R	-	0.051	0.3	mA
	$V_R=45\text{V}, T_J=100^\circ\text{C}$		-	5	15	
	$V_R=45\text{V}, T_J=150^\circ\text{C}$		-	27	75	

Thermal Characteristics

Parameter	Symbol	SL1045-T-Q1	Unit
Typical thermal resistance junction to ambient ,Note 1	$R_{\theta JA}$	73	$^\circ\text{C}/\text{W}$
Typical thermal resistance junction to ambient ,Note 2	$R_{\theta JA}$	31	$^\circ\text{C}/\text{W}$

Note : 1.FR-4 PCB, 2oz.Copper.

2.Polyimide PCB, 2oz.Copper.Cathode pad dimensions 18.8mm x 14.4mm.Anode pad dimensions 5.6mm x 14.4mm.

Rating and characteristic curves

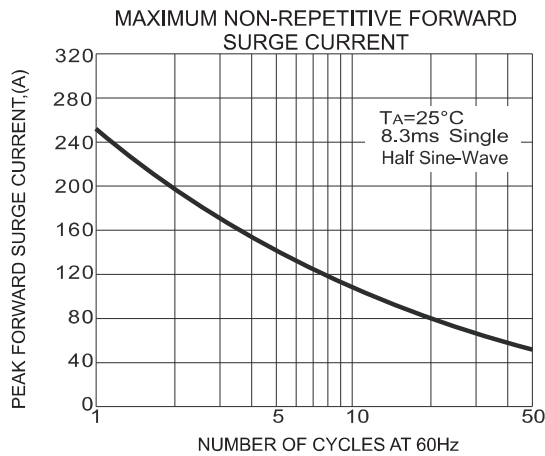
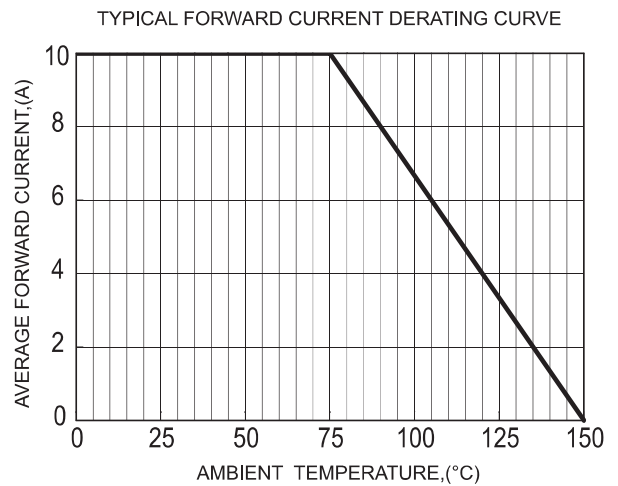
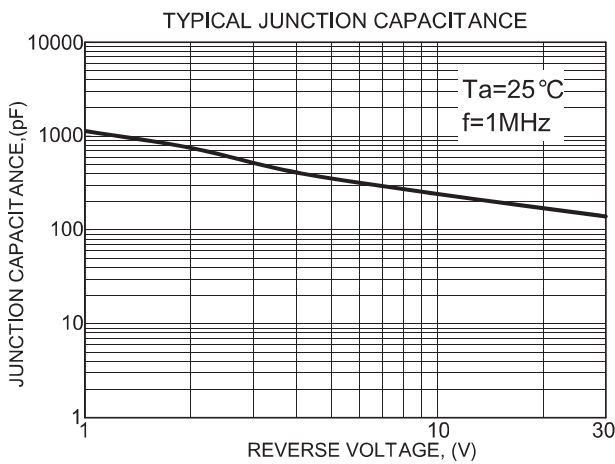
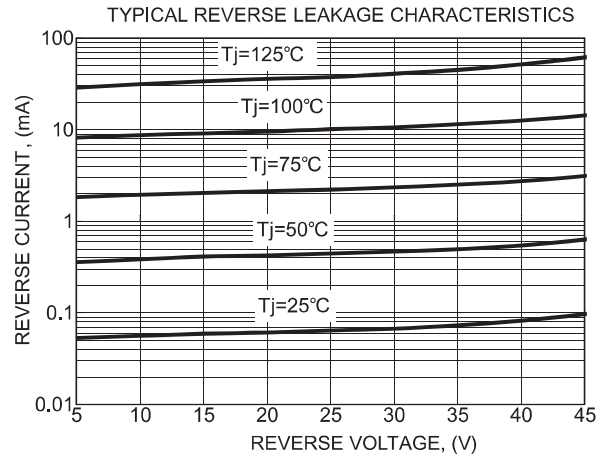
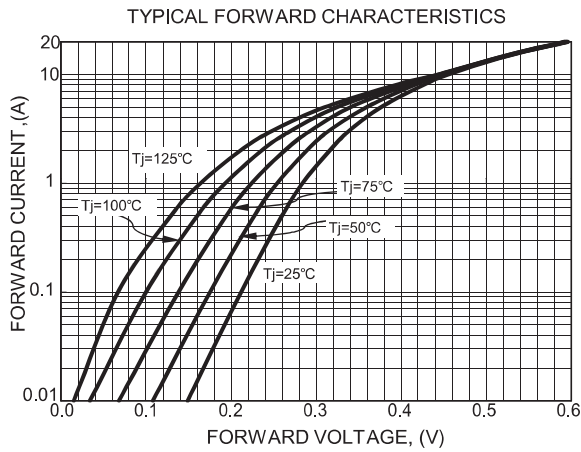

Pinning information

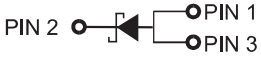
Pin	Simplified outline	Symbol
Pin2 cathode Pin1 anode Pin3 anode		

Marking

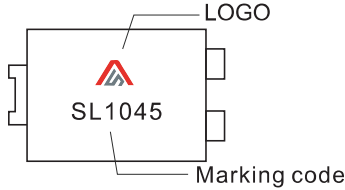
Type number	Marking code
SL1045-T-Q1	

Suggested solder pad layout

TO-277B

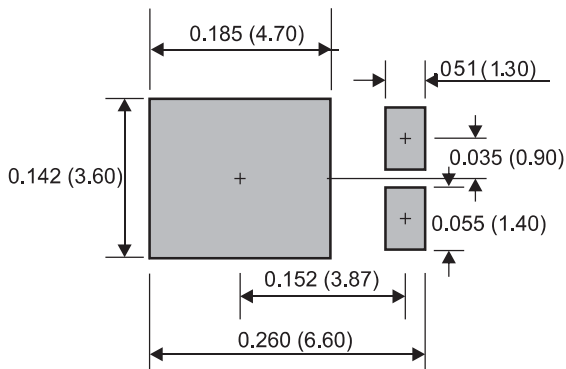

Dimensions in inches and (millimeters)