

Features

- Axial lead type devices for through hole design
- High current capability.
- Superfast recovery time for switching mode application.
- High surge current capability.
- Glass passivated chip junction structure.
- Lead-free parts meet RoHS requirements.
- Suffix "-H" indicates Halogen free parts, ex. SF21G-H.

Mechanical data

- Epoxy : UL94-V0 rated flame retardant
- Case : Molded plastic, DO-15
- Lead : Axial leads, solderable per MIL-STD-202, Method 208 guaranteed
- Polarity: Color band denotes cathode end
- Mounting Position : Any

Package outline

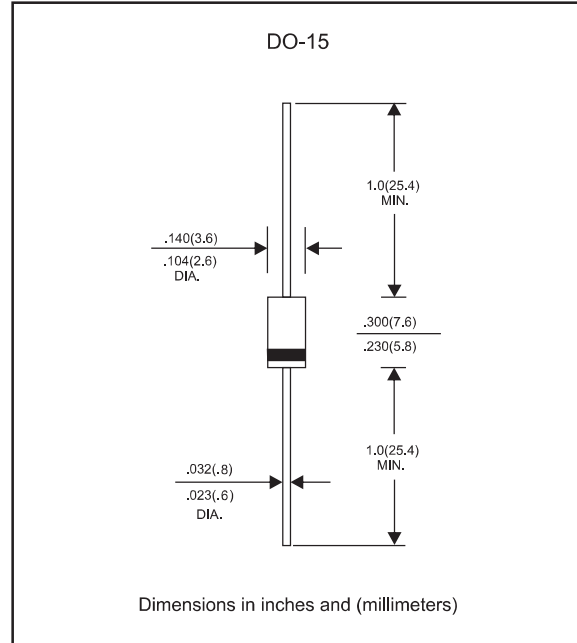

Maximum ratings and Electrical Characteristics (AT $T_A=25^\circ\text{C}$ unless otherwise noted)

PARAMETER	CONDITIONS	Symbol	MIN.	TYP.	MAX.	UNIT
Forward rectified current	Ambient temperature = 55°C	I_o			2.0	A
Forward surge current	8.3ms single half sine-wave (JEDEC methode)	I_{FSM}			50	A
Reverse current	$V_R = V_{RRM}$ $T_J = 25^\circ\text{C}$	I_R			5.0	μA
	$V_R = V_{RRM}$ $T_J = 125^\circ\text{C}$				150	
Diode junction capacitance	f=1MHz and applied 4V DC reverse voltage	C_j		60		pF
Storage temperature		T_{STG}	-65		+175	$^\circ\text{C}$

SYMBOLS	V_{RRM}^{*1} (V)	V_{RMS}^{*2} (V)	V_R^{*3} (V)	V_F^{*4} (V)	t_{rr}^{*5} (ns)	Operating temperature T_J , ($^\circ\text{C}$)
SF21G	50	35	50	0.95	35	-55 to +150
SF22G	100	70	100			
SF23G	150	105	150			
SF24G	200	140	200			
SF25G	300	210	300	1.25	35	-55 to +150
SF26G	400	280	400			
SF27G	500	350	500			
SF28G	600	420	600	1.70	35	-55 to +150

- *1 Repetitive peak reverse voltage
- *2 RMS voltage
- *3 Continuous reverse voltage
- *4 Maximum forward voltage@ $I_F=2.0\text{A}$
- *5 Maximum Reverse recovery time, note 1

Note 1. Reverse recovery time test condition, $I_F=0.5\text{A}$, $I_R=1.0\text{A}$, $I_{RR}=0.25\text{A}$

Rating and characteristic curves (SF21G THRU SF28G)

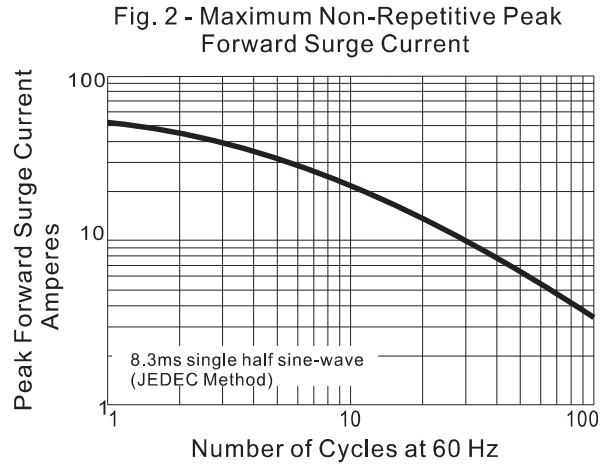
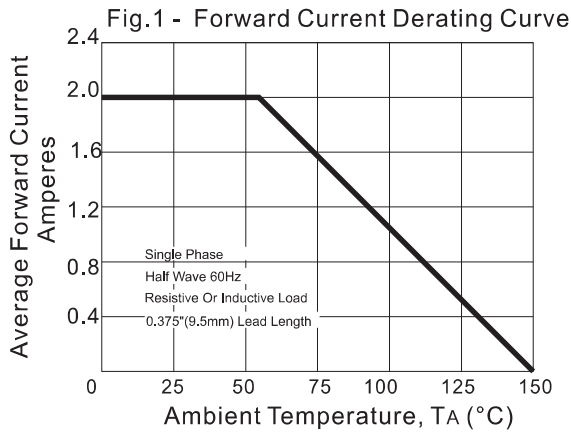

Fig. 3 - Typical Instantaneous Forward Characteristics

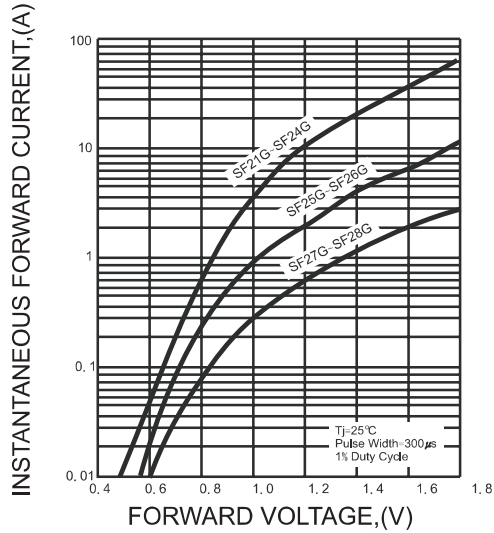

Fig. 4 - Typical Instantaneous Reverse Characteristics

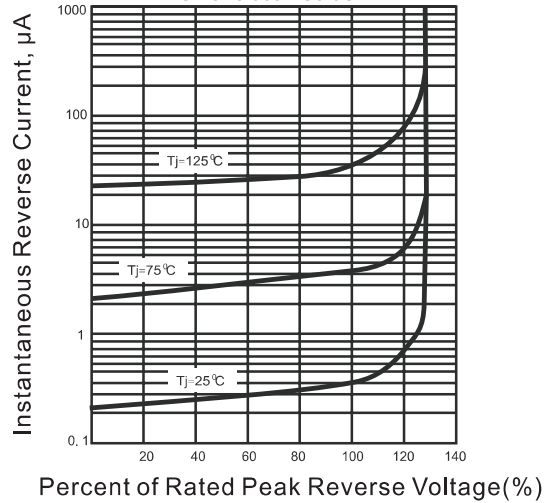

Fig. 5 - Typical Junction Capacitance

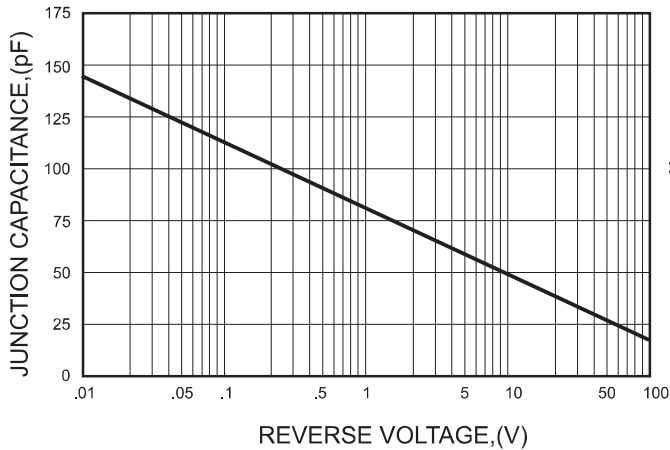
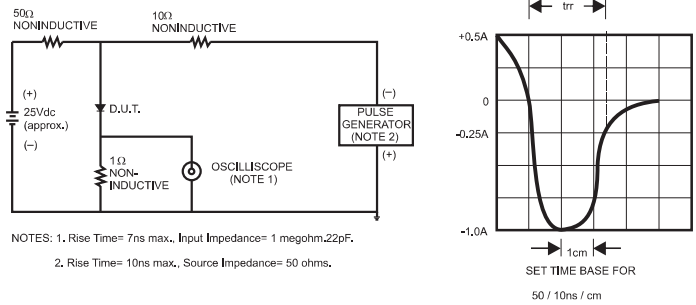



Fig. 6 - Test Circuit Diagram and Reverse Recovery Time Characteristic



Pinning information

Pin	Simplified outline	Symbol
Pin1 cathode Pin2 anode		

Marking

Type number	Marking code
SF21G	SF21G
SF22G	SF22G
SF23G	SF23G
SF24G	SF24G
SF25G	SF25G
SF26G	SF26G
SF27G	SF27G
SF28G	SF28G