

### Features

- Axial lead type devices for through hole design
- High current capability.
- Superfast recovery time for switching mode application.
- High surge current capability.
- Glass passivated chip junction.
- Lead-free parts meet RoHS requirements.
- Suffix "-H" indicates Halogen free parts, ex. SF11G-H.

### Mechanical data

- Epoxy : UL94-V0 rated flame retardant
- Case : Molded plastic, DO-41
- Lead : Axial leads, solderable per MIL-STD-202, Method 208 guaranteed
- Polarity: Color band denotes cathode end
- Mounting Position : Any

### Package outline

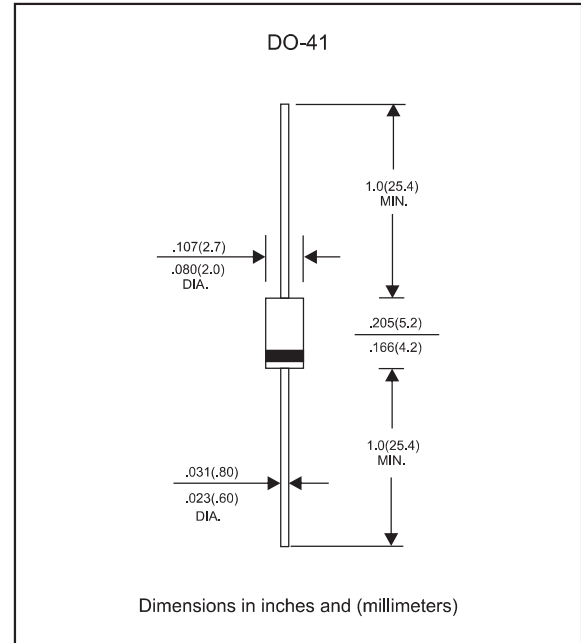

### Maximum ratings and Electrical Characteristics (AT $T_A=25^\circ\text{C}$ unless otherwise noted)

PARAMETER	CONDITIONS	Symbol	MIN.	TYP.	MAX.	UNIT
Forward rectified current	Ambient temperature = $55^\circ\text{C}$	$I_o$			1.0	A
Forward surge current	8.3ms single half sine-wave (JEDEC methode)	$I_{FSM}$			30	A
Reverse current	$V_R = V_{RRM}$ $T_J = 25^\circ\text{C}$	$I_R$			5.0	$\mu\text{A}$
	$V_R = V_{RRM}$ $T_J = 125^\circ\text{C}$				100	
Diode junction capacitance	f=1MHz and applied 4V DC reverse voltage	$C_j$		50		pF
Storage temperature		$T_{STG}$	-65		+175	$^\circ\text{C}$

SYMBOLS	$V_{RRM}^{*1}$ (V)	$V_{RMS}^{*2}$ (V)	$V_R^{*3}$ (V)	$V_F^{*4}$ (V)	$t_{rr}^{*5}$ (ns)	Operating temperature $T_J$ , ( $^\circ\text{C}$ )
SF11G	50	35	50	0.95	35	-55 to +150
SF12G	100	70	100			
SF13G	150	105	150			
SF14G	200	140	200			
SF15G	300	210	300	1.25	35	-55 to +150
SF16G	400	280	400			
SF17G	500	350	500			
SF18G	600	420	600	1.70	35	-55 to +150

- \*1 Repetitive peak reverse voltage
- \*2 RMS voltage
- \*3 Continuous reverse voltage
- \*4 Maximum forward voltage@ $I_F=1.0\text{A}$
- \*5 Maximum Reverse recovery time, note 1

Note 1. Reverse recovery time test condition,  $I_F=0.5\text{A}$ ,  $I_R=1.0\text{A}$ ,  $I_{RR}=0.25\text{A}$

# Rating and characteristic curves (SF11G THRU SF18G)

FIG.1- TEST CIRCUIT DIAGRAM AND REVERSE RECOVERY TIME CHARACTERISTIC

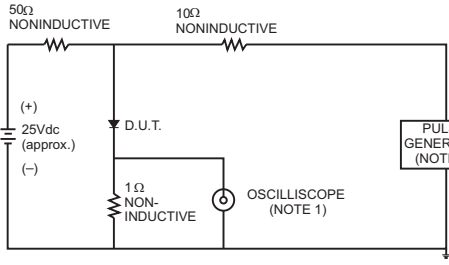

NOTES: 1. Rise Time= 7ns max., Input Impedance= 1 megohm.22pF.  
2. Rise Time= 10ns max., Source Impedance= 50 ohms.

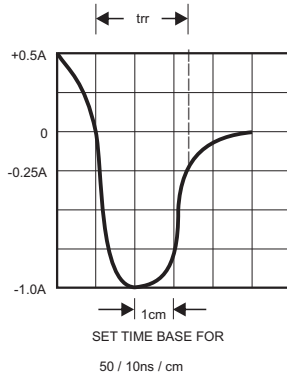

FIG.2-TYPICAL FORWARD CURRENT DERATING CURVE

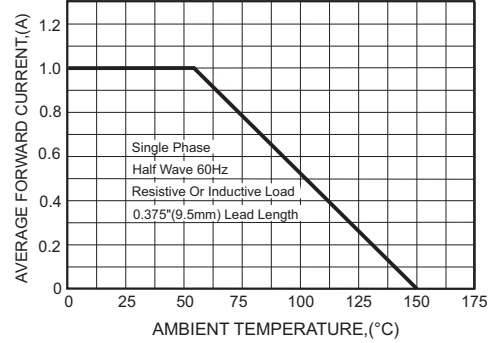

FIG.3-TYPICAL FORWARD CHARACTERISTICS

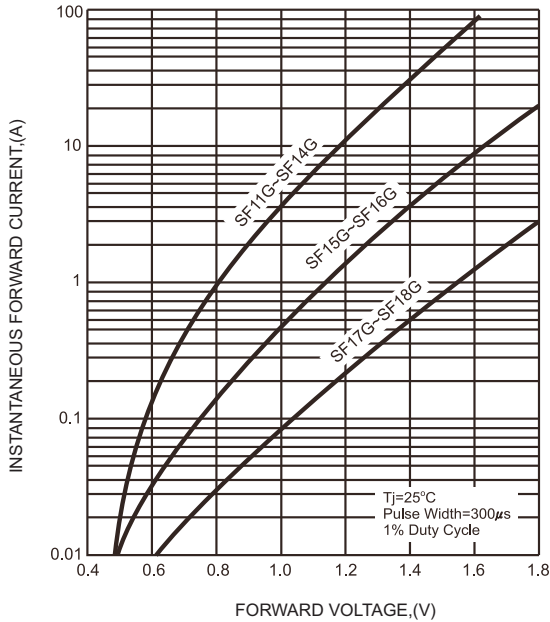

FIG.4-TYPICAL REVERSE CHARACTERISTICS

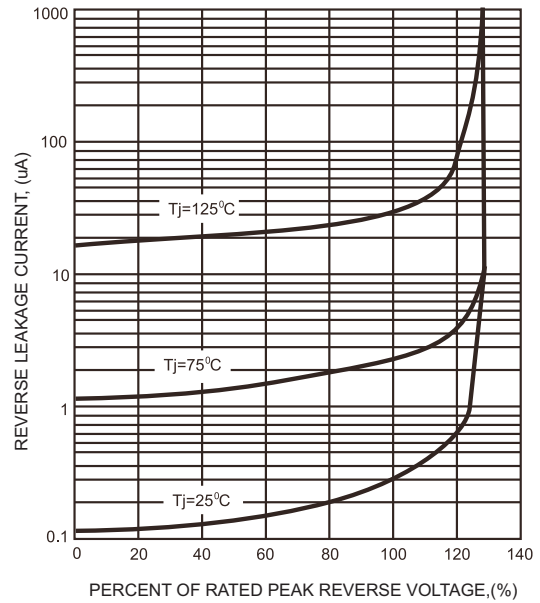

FIG.5-MAXIMUM NON-REPETITIVE FORWARD SURGE CURRENT

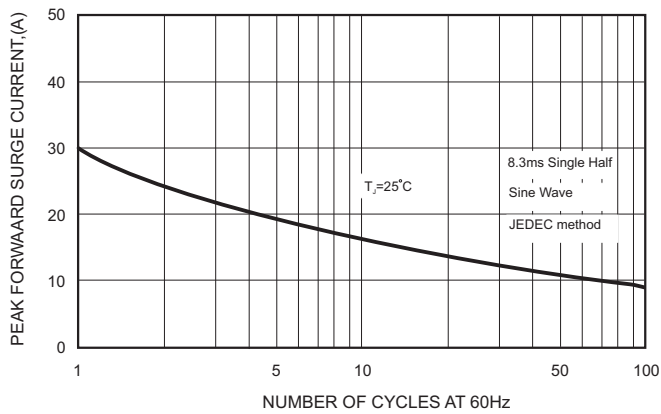
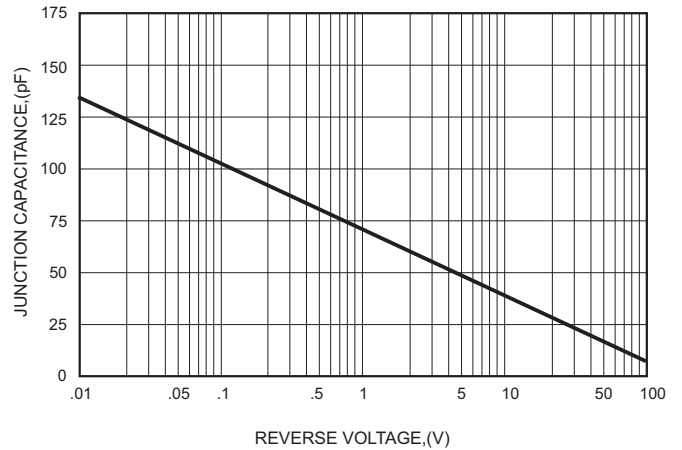



FIG.6-TYPICAL JUNCTION CAPACITANCE



### Pinning information

Pin	Simplified outline	Symbol
Pin1 cathode Pin2 anode		

### Marking

Type number	Marking code
SF11G	SF11G
SF12G	SF12G
SF13G	SF13G
SF14G	SF14G
SF15G	SF15G
SF16G	SF16G
SF17G	SF17G
SF18G	SF18G

### Taping specifications for AXIAL devices

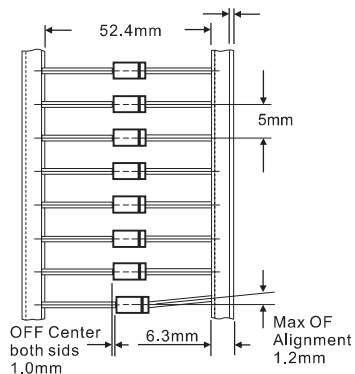

### AMMO PACKING

DEVICE CASE TYPE	Q'TY 1 (PCS / BOX)	INNER BOX SIZE (m/m)	CARTON SIZE (m/m)	Q'TY 2 (PCS / CARTON)	APPROX. CROSS WEIGHT(kg)
DO-41	5,000	260 * 83 * 160	440 * 270 * 340	50,000	20.0