

### Features

- 600W peak pulse power capability with a 10/1000us waveform, repetition rate (duty cycle): 0.01%.
- Excellent clamping capability.
- Low incremental surge resistance.
- Fast response time from 0V to  $V_{BR}$ , typically less than 1 pS for uni-directional & 5 nS for bi-directional types.
- Ultra high-speed switching.
- Glass passivated chip junction.
- Lead-free parts meet environmental standards of MIL-STD-19500 /228
- Compliant to Halogen-free
- Suffix "-Q1" for AEC-Q101

### Mechanical data

- Epoxy:UL94-V0 rated flame retardant
- Case : Molded plastic, DO-214AA /SMB
- Terminals : Solder plated, solderable per MIL-STD-750, Method 2026
- Polarity : Indicated by cathode band
- Mounting Position : Any

### Package outline

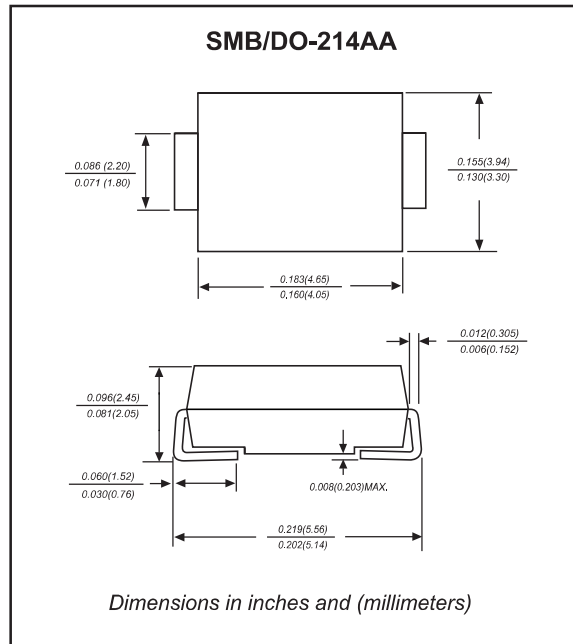

### Maximum ratings (AT $T_A=25^\circ\text{C}$ unless otherwise noted)

| PARAMETER                             | CONDITIONS  | Symbol      | MIN.        | TYP. | MAX.    | UNIT             |
|---------------------------------------|---|-------------|-------------|------|---------|------------------|
| Peak power dissipation                | with a 10/1000 us waveform, Note 1 & Fig. 1                                   | $P_{PPM}$   |             |      | 600     | W                |
| Peak pulse current                    | with a 10/1000 us waveform  | $I_{PPM}$   | See table 1 |      |         | A                |
| Steady state power dissipation        | at $T_L=75^\circ\text{C}$ lead length 0.375" (9.5 mm)                         | $P_{M(AV)}$ |             |      | 5.0     | W                |
| Peak forward surge current            | 8.3ms single half sine-wave superimposed on rated load (jedec method), note 2 | $I_{FSM}$   |             |      | 100     | A                |
| Maximum instantaneous forward voltage | for uni-directional types only, at 50A, see note 3                            | $V_F$       |             |      | 3.5/5.0 | V                |
| Operating junction temperature range  |   | $T_J$       | -55         |      | +150    | $^\circ\text{C}$ |
| Storage temperature range             |   | $T_{STG}$   | -55         |      | +150    | $^\circ\text{C}$ |

Note 1. Non-repetitive current pulse, per Fig. 3 and derated above  $T_A=25^\circ\text{C}$  per Fig. 2

2. Measured on 8.3 ms single half sine-wave or equivalent square wave, duty cycle=4 pulses per minute maximum

3.  $V_F < 3.5\text{V}$ . for devices of  $V_{BR} < 200\text{V}$ , and  $V_F < 5.0\text{V}$ . for devices of  $V_{BR} > 201\text{V}$

### Electrical characteristics (at T =25°C unless otherwise noted)

| Type Number  |               | Marking |       | Reverse Stand-Off Voltage | Breakdown Voltage Min. @I <sub>T</sub> | Breakdown Voltage Max. @ I <sub>T</sub> | Test Current        | Maximum Clamping Voltage @I <sub>PP</sub> | Peak Pulse Current  | Reverse Leakage @V <sub>RMW</sub> |
|--------------|---------------|---------|-------|---------------------------|--|---|---------------------|---|---------------------|-----------------------------------|
| (Uni)        | (Bi)          | (Uni)   | (Bi)  | V <sub>RMW</sub> (V)      | V <sub>BR MIN</sub> (V)                | V <sub>BR MAX</sub> (V)                 | I <sub>T</sub> (mA) | V <sub>C</sub> (V)                        | I <sub>PP</sub> (A) | I <sub>R</sub> (uA)               |
| P6SMB6.8-Q1  | P6SMB6.8C-Q1  | 6V8     | 6V8C  | 5.50                      | 6.12                                   | 7.48                                    | 10.0                | 10.8                                      | 55.6                | 1000.0                            |
| P6SMB6.8A-Q1 | P6SMB6.8CA-Q1 | 6V8A    | 6V8CA | 5.80                      | 6.45                                   | 7.14                                    | 10.0                | 10.5                                      | 58.1                | 1000.0                            |
| P6SMB7.5-Q1  | P6SMB7.5C-Q1  | 7V5     | 7V5C  | 6.05                      | 6.75                                   | 8.25                                    | 10.0                | 11.7                                      | 51.3                | 500.0                             |
| P6SMB7.5A-Q1 | P6SMB7.5CA-Q1 | 7V5A    | 7V5CA | 6.40                      | 7.13                                   | 7.88                                    | 10.0                | 11.3                                      | 54.0                | 500.0                             |
| P6SMB8.2-Q1  | P6SMB8.2C-Q1  | 8V2     | 8V2C  | 6.63                      | 7.38                                   | 9.02                                    | 10.0                | 12.5                                      | 48.0                | 200.0                             |
| P6SMB8.2A-Q1 | P6SMB8.2CA-Q1 | 8V2A    | 8V2CA | 7.02                      | 7.79                                   | 8.61                                    | 10.0                | 12.1                                      | 50.4                | 200.0                             |
| P6SMB9.1-Q1  | P6SMB9.1C-Q1  | 9V1     | 9V1C  | 7.37                      | 8.19                                   | 10.0                                    | 1.0                 | 13.8                                      | 43.5                | 50.0                              |
| P6SMB9.1A-Q1 | P6SMB9.1CA-Q1 | 9V1A    | 9V1CA | 7.78                      | 8.65                                   | 9.55                                    | 1.0                 | 13.4                                      | 45.5                | 50.0                              |
| P6SMB10-Q1   | P6SMB10C-Q1   | 10      | 10C   | 8.10                      | 9.00                                   | 11.0                                    | 1.0                 | 15.0                                      | 40.0                | 10.0                              |
| P6SMB10A-Q1  | P6SMB10CA-Q1  | 10A     | 10CA  | 8.55                      | 9.50                                   | 10.5                                    | 1.0                 | 14.5                                      | 42.1                | 10.0                              |
| P6SMB11-Q1   | P6SMB11C-Q1   | 11      | 11C   | 8.92                      | 9.90                                   | 12.1                                    | 1.0                 | 16.2                                      | 37.0                | 5.0                               |
| P6SMB11A-Q1  | P6SMB11CA-Q1  | 11A     | 11CA  | 9.40                      | 10.5                                   | 11.6                                    | 1.0                 | 15.6                                      | 39.1                | 5.0                               |
| P6SMB12-Q1   | P6SMB12C-Q1   | 12      | 12C   | 9.72                      | 10.8                                   | 13.2                                    | 1.0                 | 17.3                                      | 34.7                | 5.0                               |
| P6SMB12A-Q1  | P6SMB12CA-Q1  | 12A     | 12CA  | 10.2                      | 11.4                                   | 12.6                                    | 1.0                 | 16.7                                      | 36.5                | 5.0                               |
| P6SMB13-Q1   | P6SMB13C-Q1   | 13      | 13C   | 10.5                      | 11.7                                   | 14.3                                    | 1.0                 | 19.0                                      | 31.6                | 5.0                               |
| P6SMB13A-Q1  | P6SMB13CA-Q1  | 13A     | 13CA  | 11.1                      | 12.4                                   | 13.7                                    | 1.0                 | 18.2                                      | 33.5                | 5.0                               |
| P6SMB15-Q1   | P6SMB15C-Q1   | 15      | 15C   | 12.1                      | 13.5                                   | 16.5                                    | 1.0                 | 22.0                                      | 27.3                | 5.0                               |
| P6SMB15A-Q1  | P6SMB15CA-Q1  | 15A     | 15CA  | 12.8                      | 14.3                                   | 15.8                                    | 1.0                 | 21.2                                      | 28.8                | 5.0                               |
| P6SMB16-Q1   | P6SMB16C-Q1   | 16      | 16C   | 12.9                      | 14.4                                   | 17.6                                    | 1.0                 | 23.5                                      | 25.5                | 5.0                               |
| P6SMB16A-Q1  | P6SMB16CA-Q1  | 16A     | 16CA  | 13.6                      | 15.2                                   | 16.8                                    | 1.0                 | 22.5                                      | 27.1                | 5.0                               |
| P6SMB18-Q1   | P6SMB18C-Q1   | 18      | 18C   | 14.5                      | 16.2                                   | 19.8                                    | 1.0                 | 26.5                                      | 22.6                | 5.0                               |
| P6SMB18A-Q1  | P6SMB18CA-Q1  | 18A     | 18CA  | 15.3                      | 17.1                                   | 18.9                                    | 1.0                 | 25.2                                      | 24.2                | 5.0                               |
| P6SMB20-Q1   | P6SMB20C-Q1   | 20      | 20C   | 16.2                      | 18.0                                   | 22.0                                    | 1.0                 | 29.1                                      | 20.6                | 5.0                               |
| P6SMB20A-Q1  | P6SMB20CA-Q1  | 20A     | 20CA  | 17.1                      | 19.0                                   | 21.0                                    | 1.0                 | 27.7                                      | 22.0                | 5.0                               |
| P6SMB22-Q1   | P6SMB22C-Q1   | 22      | 22C   | 17.8                      | 19.8                                   | 24.2                                    | 1.0                 | 31.9                                      | 18.8                | 5.0                               |
| P6SMB22A-Q1  | P6SMB22CA-Q1  | 22A     | 22CA  | 18.8                      | 20.9                                   | 23.1                                    | 1.0                 | 30.6                                      | 19.9                | 5.0                               |
| P6SMB24-Q1   | P6SMB24C-Q1   | 24      | 24C   | 19.4                      | 21.6                                   | 26.4                                    | 1.0                 | 34.7                                      | 17.3                | 5.0                               |
| P6SMB24A-Q1  | P6SMB24CA-Q1  | 24A     | 24CA  | 20.5                      | 22.8                                   | 25.2                                    | 1.0                 | 33.2                                      | 18.4                | 5.0                               |
| P6SMB27-Q1   | P6SMB27C-Q1   | 27      | 27C   | 21.8                      | 24.3                                   | 29.7                                    | 1.0                 | 39.1                                      | 15.3                | 5.0                               |
| P6SMB27A-Q1  | P6SMB27CA-Q1  | 27A     | 27CA  | 23.1                      | 25.7                                   | 28.4                                    | 1.0                 | 37.5                                      | 16.3                | 5.0                               |
| P6SMB30-Q1   | P6SMB30C-Q1   | 30      | 30C   | 24.3                      | 27.0                                   | 33.0                                    | 1.0                 | 43.5                                      | 13.8                | 5.0                               |
| P6SMB30A-Q1  | P6SMB30CA-Q1  | 30A     | 30CA  | 25.6                      | 28.5                                   | 31.5                                    | 1.0                 | 41.4                                      | 14.7                | 5.0                               |

※ For Bi-directional type having VRWM of 10 Volts and less, the IR limit is double

### Electrical characteristics (at T = 25°C unless otherwise noted)

| Type Number  |               | Marking |       | Reverse Stand-Off Voltage | Breakdown Voltage Min. @ I <sub>T</sub> | Breakdown Voltage Max. @ I <sub>T</sub> | Test Current        | Maximum Clamping Voltage @ I <sub>PP</sub> | Peak Pulse Current  | Reverse Leakage @ V <sub>RMW</sub> |
|--------------|---------------|---------|-------|---------------------------|---|---|---------------------|--|---------------------|------------------------------------|
| (Uni)        | (Bi)          | (Uni)   | (Bi)  | V <sub>RMW</sub> (V)      | V <sub>BR MIN</sub> (V)                 | V <sub>BR MAX</sub> (V)                 | I <sub>T</sub> (mA) | V <sub>C</sub> (V)                         | I <sub>PP</sub> (A) | I <sub>R</sub> (μA)                |
| P6SMB33-Q1   | P6SMB33C-Q1   | 33      | 33C   | 26.8                      | 29.7                                    | 36.3                                    | 1.0                 | 47.7                                       | 12.6                | 5.0                                |
| P6SMB33A-Q1  | P6SMB33CA-Q1  | 33A     | 33CA  | 28.2                      | 31.4                                    | 34.7                                    | 1.0                 | 45.7                                       | 13.3                | 5.0                                |
| P6SMB36-Q1   | P6SMB36C-Q1   | 36      | 36C   | 29.1                      | 32.4                                    | 39.6                                    | 1.0                 | 52.0                                       | 11.5                | 5.0                                |
| P6SMB36A-Q1  | P6SMB36CA-Q1  | 36A     | 36CA  | 30.8                      | 34.2                                    | 37.8                                    | 1.0                 | 49.9                                       | 12.2                | 5.0                                |
| P6SMB39-Q1   | P6SMB39C-Q1   | 39      | 39C   | 31.6                      | 35.1                                    | 42.9                                    | 1.0                 | 56.4                                       | 10.6                | 5.0                                |
| P6SMB39A-Q1  | P6SMB39CA-Q1  | 39A     | 39CA  | 33.3                      | 37.1                                    | 41.0                                    | 1.0                 | 53.9                                       | 11.3                | 5.0                                |
| P6SMB43-Q1   | P6SMB43C-Q1   | 43      | 43C   | 34.8                      | 38.7                                    | 47.3                                    | 1.0                 | 61.9                                       | 9.7                 | 5.0                                |
| P6SMB43A-Q1  | P6SMB43CA-Q1  | 43A     | 43CA  | 36.8                      | 40.9                                    | 45.2                                    | 1.0                 | 59.3                                       | 10.3                | 5.0                                |
| P6SMB47-Q1   | P6SMB47C-Q1   | 47      | 47C   | 38.1                      | 42.3                                    | 51.7                                    | 1.0                 | 67.8                                       | 8.8                 | 5.0                                |
| P6SMB47A-Q1  | P6SMB47CA-Q1  | 47A     | 47CA  | 40.2                      | 44.7                                    | 49.4                                    | 1.0                 | 64.8                                       | 9.4                 | 5.0                                |
| P6SMB51-Q1   | P6SMB51C-Q1   | 51      | 51C   | 41.3                      | 45.9                                    | 56.1                                    | 1.0                 | 73.5                                       | 8.2                 | 5.0                                |
| P6SMB51A-Q1  | P6SMB51CA-Q1  | 51A     | 51CA  | 43.6                      | 48.5                                    | 53.6                                    | 1.0                 | 70.1                                       | 8.7                 | 5.0                                |
| P6SMB56-Q1   | P6SMB56C-Q1   | 56      | 56C   | 45.4                      | 50.4                                    | 61.6                                    | 1.0                 | 80.5                                       | 7.5                 | 5.0                                |
| P6SMB56A-Q1  | P6SMB56CA-Q1  | 56A     | 56CA  | 47.8                      | 53.2                                    | 58.8                                    | 1.0                 | 77.0                                       | 7.9                 | 5.0                                |
| P6SMB62-Q1   | P6SMB62C-Q1   | 62      | 62C   | 50.2                      | 55.8                                    | 68.2                                    | 1.0                 | 89.0                                       | 6.7                 | 5.0                                |
| P6SMB62A-Q1  | P6SMB62CA-Q1  | 62A     | 62CA  | 53.0                      | 58.9                                    | 65.1                                    | 1.0                 | 85.0                                       | 7.2                 | 5.0                                |
| P6SMB68-Q1   | P6SMB68C-Q1   | 68      | 68C   | 55.1                      | 61.2                                    | 74.8                                    | 1.0                 | 98.0                                       | 6.1                 | 5.0                                |
| P6SMB68A-Q1  | P6SMB68CA-Q1  | 68A     | 68CA  | 58.1                      | 64.6                                    | 71.4                                    | 1.0                 | 92.0                                       | 6.6                 | 5.0                                |
| P6SMB75-Q1   | P6SMB75C-Q1   | 75      | 75C   | 60.7                      | 67.5                                    | 82.5                                    | 1.0                 | 108  | 5.6                 | 5.0                                |
| P6SMB75A-Q1  | P6SMB75CA-Q1  | 75A     | 75CA  | 64.1                      | 71.3                                    | 78.8                                    | 1.0                 | 103  | 5.9                 | 5.0                                |
| P6SMB82-Q1   | P6SMB82C-Q1   | 82      | 82C   | 66.4                      | 73.8                                    | 90.2                                    | 1.0                 | 118  | 5.1                 | 5.0                                |
| P6SMB82A-Q1  | P6SMB82CA-Q1  | 82A     | 82CA  | 70.1                      | 77.9                                    | 86.1                                    | 1.0                 | 113  | 5.4                 | 5.0                                |
| P6SMB91-Q1   | P6SMB91C-Q1   | 91      | 91C   | 73.7                      | 81.9                                    | 100                                     | 1.0                 | 131  | 4.6                 | 5.0                                |
| P6SMB91A-Q1  | P6SMB91CA-Q1  | 91A     | 91CA  | 77.8                      | 86.5                                    | 95.5                                    | 1.0                 | 125  | 4.9                 | 5.0                                |
| P6SMB100-Q1  | P6SMB100C-Q1  | 100     | 100C  | 81.0                      | 90.0                                    | 110                                     | 1.0                 | 144  | 4.2                 | 5.0                                |
| P6SMB100A-Q1 | P6SMB100CA-Q1 | 100A    | 100CA | 85.5                      | 95.0                                    | 105                                     | 1.0                 | 137  | 4.5                 | 5.0                                |
| P6SMB110-Q1  | P6SMB110C-Q1  | 110     | 110C  | 89.2                      | 99.0                                    | 121                                     | 1.0                 | 158  | 3.8                 | 5.0                                |
| P6SMB110A-Q1 | P6SMB110CA-Q1 | 110A    | 110CA | 94.0                      | 105                                     | 116                                     | 1.0                 | 152  | 4.0                 | 5.0                                |
| P6SMB120-Q1  | P6SMB120C-Q1  | 120     | 120C  | 97.2                      | 108                                     | 132                                     | 1.0                 | 173  | 3.5                 | 5.0                                |
| P6SMB120A-Q1 | P6SMB120CA-Q1 | 120A    | 120CA | 102                       | 114                                     | 126                                     | 1.0                 | 165  | 3.7                 | 5.0                                |
| P6SMB130-Q1  | P6SMB130C-Q1  | 130     | 130C  | 105                       | 117                                     | 143                                     | 1.0                 | 187  | 3.2                 | 5.0                                |
| P6SMB130A-Q1 | P6SMB130CA-Q1 | 130A    | 130CA | 111                       | 124                                     | 137                                     | 1.0                 | 179  | 3.4                 | 5.0                                |
| P6SMB150-Q1  | P6SMB150C-Q1  | 150     | 150C  | 121                       | 135                                     | 165                                     | 1.0                 | 215  | 2.8                 | 5.0                                |
| P6SMB150A-Q1 | P6SMB150CA-Q1 | 150A    | 150CA | 128                       | 143                                     | 158                                     | 1.0                 | 207  | 2.9                 | 5.0                                |
| P6SMB160-Q1  | P6SMB160C-Q1  | 160     | 160C  | 130                       | 144                                     | 176                                     | 1.0                 | 230  | 2.6                 | 5.0                                |
| P6SMB160A-Q1 | P6SMB160CA-Q1 | 160A    | 160CA | 136                       | 152                                     | 168                                     | 1.0                 | 219  | 2.8                 | 5.0                                |

※ For Bi-directional type having VRWM of 10 Volts and less, the IR limit is double

### Electrical characteristics (at T =25°C unless otherwise noted)

| Type Number  |               | Marking |       | Reverse Stand-Off Voltage | Breakdown Voltage Min. @I <sub>T</sub> | Breakdown Voltage Max. @ I <sub>T</sub> | Test Current        | Maximum Clamping Voltage @I <sub>PP</sub> | Peak Pulse Current  | Reverse Leakage @V <sub>RMW</sub> |
|--------------|---------------|---------|-------|---------------------------|--|---|---------------------|---|---------------------|-----------------------------------|
| (Uni)        | (Bi)          | (Uni)   | (Bi)  | V <sub>RMW</sub> (V)      | V <sub>BR MIN</sub> (V)                | V <sub>BR MAX</sub> (V)                 | I <sub>T</sub> (mA) | V <sub>C</sub> (V)                        | I <sub>PP</sub> (A) | I <sub>R</sub> (uA)               |
| P6SMB170-Q1  | P6SMB170C-Q1  | 170     | 170C  | 138                       | 153                                    | 187                                     | 1.0                 | 244                                       | 2.5                 | 5.0                               |
| P6SMB170A-Q1 | P6SMB170CA-Q1 | 170A    | 170CA | 145                       | 162                                    | 179                                     | 1.0                 | 234                                       | 2.6                 | 5.0                               |
| P6SMB180-Q1  | P6SMB180C-Q1  | 180     | 180C  | 146                       | 162                                    | 198                                     | 1.0                 | 258                                       | 2.3                 | 5.0                               |
| P6SMB180A-Q1 | P6SMB180CA-Q1 | 180A    | 180CA | 154                       | 171                                    | 189                                     | 1.0                 | 246                                       | 2.5                 | 5.0                               |
| P6SMB200-Q1  | P6SMB200C-Q1  | 200     | 200C  | 162                       | 180                                    | 220                                     | 1.0                 | 287                                       | 2.1                 | 5.0                               |
| P6SMB200A-Q1 | P6SMB200CA-Q1 | 200A    | 200CA | 171                       | 190                                    | 210                                     | 1.0                 | 274                                       | 2.2                 | 5.0                               |
| P6SMB220-Q1  | P6SMB220C-Q1  | 220     | 220C  | 175                       | 198                                    | 242                                     | 1.0                 | 344                                       | 1.7                 | 5.0                               |
| P6SMB220A-Q1 | P6SMB220CA-Q1 | 220A    | 220CA | 185                       | 209                                    | 231                                     | 1.0                 | 328                                       | 1.9                 | 5.0                               |
| P6SMB250-Q1  | P6SMB250C-Q1  | 250     | 250C  | 202                       | 225                                    | 275                                     | 1.0                 | 360                                       | 1.7                 | 5.0                               |
| P6SMB250A-Q1 | P6SMB250CA-Q1 | 250A    | 250CA | 214                       | 237                                    | 263                                     | 1.0                 | 344                                       | 1.8                 | 5.0                               |
| P6SMB300-Q1  | P6SMB300C-Q1  | 300     | 300C  | 243                       | 270                                    | 330                                     | 1.0                 | 430                                       | 1.4                 | 5.0                               |
| P6SMB300A-Q1 | P6SMB300CA-Q1 | 300A    | 300CA | 256                       | 285                                    | 315                                     | 1.0                 | 414                                       | 1.5                 | 5.0                               |
| P6SMB350-Q1  | P6SMB350C-Q1  | 350     | 350C  | 284                       | 315                                    | 385                                     | 1.0                 | 504                                       | 1.2                 | 5.0                               |
| P6SMB350A-Q1 | P6SMB350CA-Q1 | 350A    | 350CA | 300                       | 333                                    | 368                                     | 1.0                 | 482                                       | 1.3                 | 5.0                               |
| P6SMB400-Q1  | P6SMB400C-Q1  | 400     | 400C  | 324                       | 360                                    | 440                                     | 1.0                 | 574                                       | 1.0                 | 5.0                               |
| P6SMB400A-Q1 | P6SMB400CA-Q1 | 400A    | 400CA | 342                       | 380                                    | 420                                     | 1.0                 | 548                                       | 1.1                 | 5.0                               |
| P6SMB440-Q1  | P6SMB440C-Q1  | 440     | 440C  | 356                       | 396                                    | 484                                     | 1.0                 | 631                                       | 0.95                | 5.0                               |
| P6SMB440A-Q1 | P6SMB440CA-Q1 | 440A    | 440CA | 376                       | 418                                    | 462                                     | 1.0                 | 602                                       | 1.0                 | 5.0                               |

※ For Bi-directional type having VRWM of 10 Volts and less, the IR limit is double

## Rating and characteristic curves (P6SMB-Q1 Series)

Fig.1 - PEAK PULSE POWER RATING CURVE

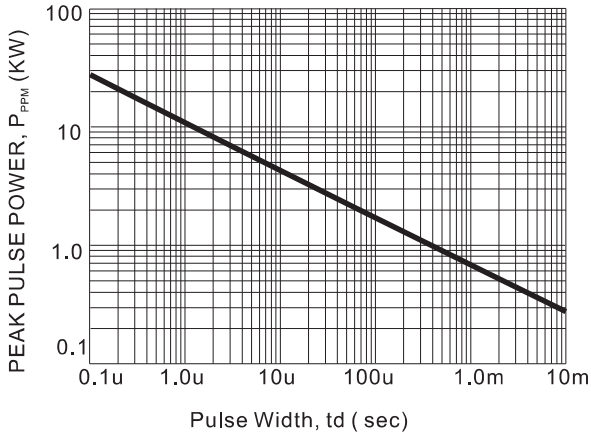

Fig.2 - PULSE DERATING CURVE

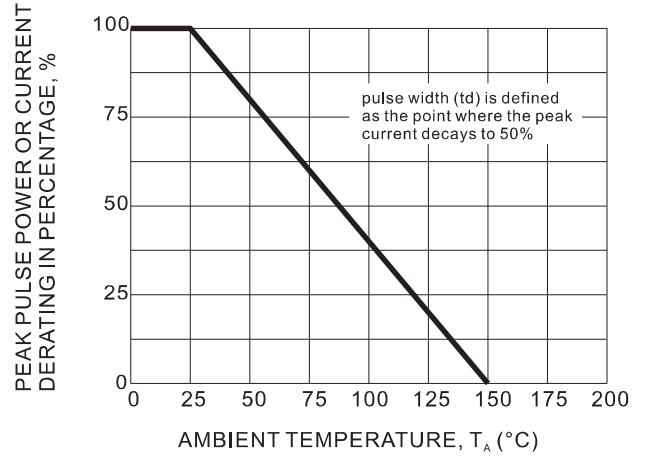

Fig.3 - PULSE WAVEFORM

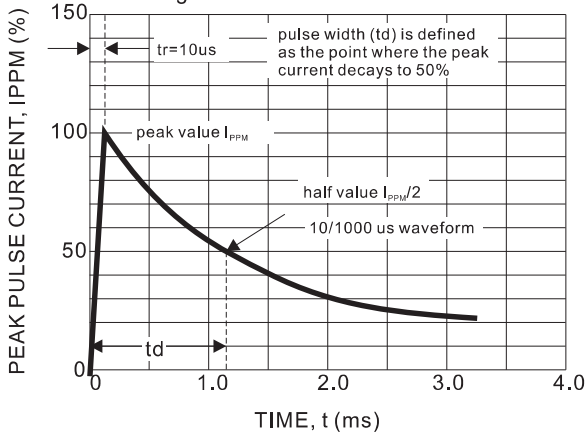

Fig.4 - TYPICAL JUNCTION CAPACITANCE

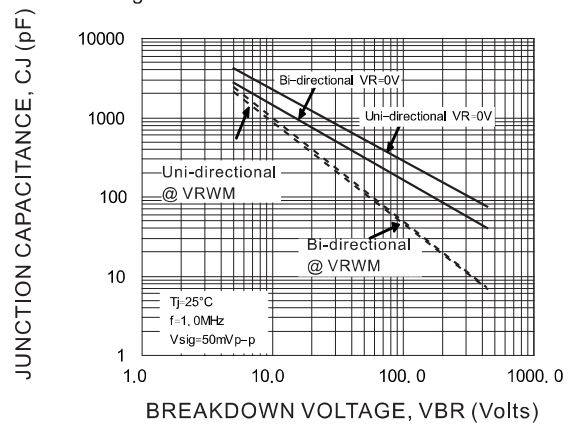

Fig.5 - STEADY STATE POWER DERATING CURVE

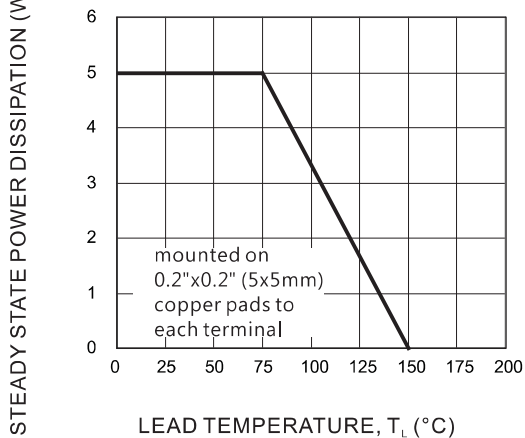
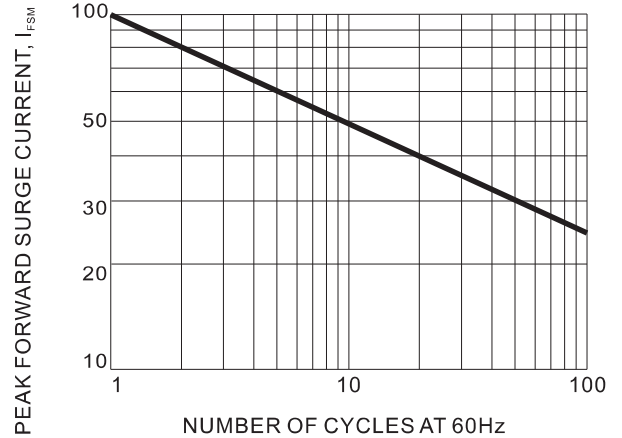





Fig.6 - MAXIMUM NON-REPETITIVE FORWARD SURGE CURRENT



### Pinning information

| Pin   | Simplified outline   | Symbol  |
|---|--|---|
| Uni-Directional<br>Pin1 cathode<br>Pin2 anode |  |  |
| Bi-Directional                                |   |  |

### Marking

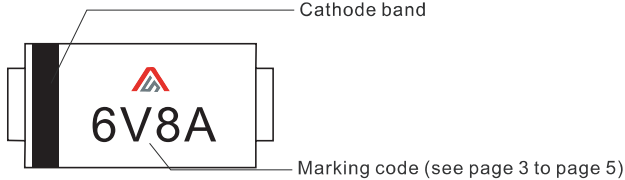
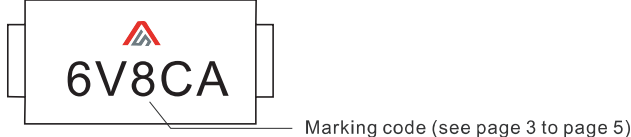
| Type number     | Example   |
|-----------------|---|
| Uni-Directional |  <p>Cathode band</p> <p>6V8A</p> <p>Marking code (see page 3 to page 5)</p> |
| Bi-Directional  |  <p>6V8CA</p> <p>Marking code (see page 3 to page 5)</p>                    |

### Suggested solder pad layout

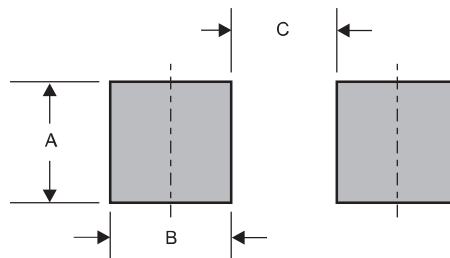

Dimensions in inches and (millimeters)

| PACKAGE | A            | B            | C            |
|---------|--------------|--------------|--------------|
| SMB     | 0.078 (2.00) | 0.059 (1.50) | 0.110 (2.80) |