

Features

- 600W peak pulse power capability with a 10/1000us waveform, repetition rate (duty cycle): 0.01%.
- Excellent clamping capability.
- Low incremental surge resistance.
- Fast response time from 0V to V_{BR} , typically less than 1 pS for uni-directional & 5 nS for bi-directional types.
- Ultra high-speed switching.
- Glass passivated chip junction.
- Lead-free parts meet environmental standards of MIL-STD-19500 /228
- Compliant to Halogen-free

Mechanical data

- Epoxy:UL94-V0 rated flame retardant
- Case : Molded plastic, DO-214AA /SMB
- Terminals : Solder plated, solderable per MIL-STD-750, Method 2026
- Polarity : Indicated by cathode band
- Mounting Position : Any

Package outline

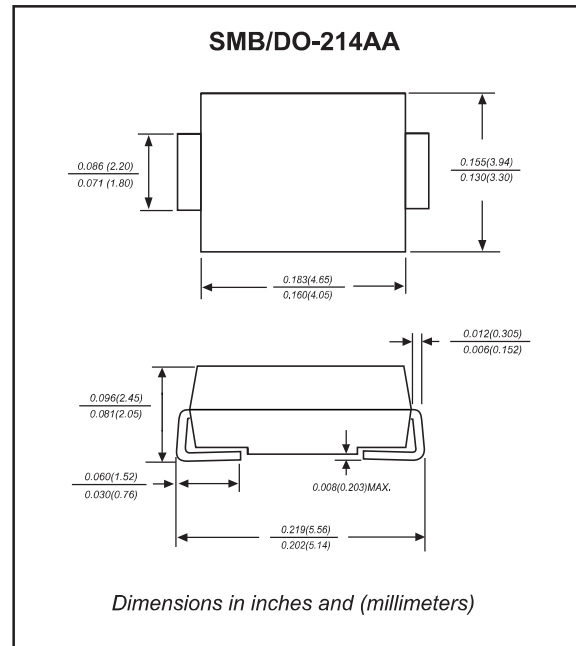

Maximum ratings (AT $T_A=25^\circ\text{C}$ unless otherwise noted)

PARAMETER	CONDITIONS	Symbol	MIN.	TYP.	MAX.	UNIT
Peak power dissipation	with a 10/1000 us waveform, Note 1 & Fig. 1	P_{PPM}			600	W
Peak pulse current	with a 10/1000 us waveform	I_{PPM}	See table 1			A
Steady state power dissipation	at $T_L=75^\circ\text{C}$ lead length 0.375" (9.5 mm)	$P_{M(AV)}$			5.0	W
Peak forward surge current	8.3ms single half sine-wave superimposed on rated load (jedec method), note 2	I_{FSM}			100	A
Maximum instantaneous forward voltage	for uni-directional types only, at 50A, see note 3	V_F			3.5/5.0	V
Operating junction temperature range		T_J	-55		+150	$^\circ\text{C}$
Storage temperature range		T_{STG}	-55		+150	$^\circ\text{C}$

Note 1. Non-repetitive current pulse, per Fig. 3 and derated above $T_A=25^\circ\text{C}$ per Fig. 2
 2. Measured on 8.3 ms single half sine-wave or equivalent square wave, duty cycle=4 pulses per minute maximum
 3. $V_F<3.5\text{V}$. for devices of $V_{BR}<200\text{V}$, and $V_F<5.0\text{V}$. for devices of $V_{BR}>201\text{V}$

Electrical Specification @ Tamb 25°C

Type Number		Marking		Reverse Stand-Off Voltage	Breakdown Voltage Min. @I _T	Breakdown Voltage Max. @ I _T	Test Current	Maximum Clamping Voltage @I _{PP}	Peak Pulse Current	Reverse Leakage @V _{RMW}
(Uni)	(Bi)	(Uni)	(Bi)	V _{RMW} (V)	V _{BR MIN} (V)	V _{BR MAX} (V)	I _T (mA)	V _C (V)	I _{PP} (A)	I _R (uA)
P6SMB6.8	P6SMB6.8C	6V8	6V8C	5.50	6.12	7.48	10.0	10.8	55.6	1000.0
P6SMB6.8A	P6SMB6.8CA	6V8A	6V8CA	5.80	6.45	7.14	10.0	10.5	58.1	1000.0
P6SMB7.5	P6SMB7.5C	7V5	7V5C	6.05	6.75	8.25	10.0	11.7	51.3	500.0
P6SMB7.5A	P6SMB7.5CA	7V5A	7V5CA	6.40	7.13	7.88	10.0	11.3	54.0	500.0
P6SMB8.2	P6SMB8.2C	8V2	8V2C	6.63	7.38	9.02	10.0	12.5	48.0	200.0
P6SMB8.2A	P6SMB8.2CA	8V2A	8V2CA	7.02	7.79	8.61	10.0	12.1	50.4	200.0
P6SMB9.1	P6SMB9.1C	9V1	9V1C	7.37	8.19	10.0	1.0	13.8	43.5	50.0
P6SMB9.1A	P6SMB9.1CA	9V1A	9V1CA	7.78	8.65	9.55	1.0	13.4	45.5	50.0
P6SMB10	P6SMB10C	10	10C	8.10	9.00	11.0	1.0	15.0	40.0	10.0
P6SMB10A	P6SMB10CA	10A	10CA	8.55	9.50	10.5	1.0	14.5	42.1	10.0
P6SMB11	P6SMB11C	11	11C	8.92	9.90	12.1	1.0	16.2	37.0	5.0
P6SMB11A	P6SMB11CA	11A	11CA	9.40	10.5	11.6	1.0	15.6	39.1	5.0
P6SMB12	P6SMB12C	12	12C	9.72	10.8	13.2	1.0	17.3	34.7	5.0
P6SMB12A	P6SMB12CA	12A	12CA	10.2	11.4	12.6	1.0	16.7	36.5	5.0
P6SMB13	P6SMB13C	13	13C	10.5	11.7	14.3	1.0	19.0	31.6	5.0
P6SMB13A	P6SMB13CA	13A	13CA	11.1	12.4	13.7	1.0	18.2	33.5	5.0
P6SMB15	P6SMB15C	15	15C	12.1	13.5	16.5	1.0	22.0	27.3	5.0
P6SMB15A	P6SMB15CA	15A	15CA	12.8	14.3	15.8	1.0	21.2	28.8	5.0
P6SMB16	P6SMB16C	16	16C	12.9	14.4	17.6	1.0	23.5	25.5	5.0
P6SMB16A	P6SMB16CA	16A	16CA	13.6	15.2	16.8	1.0	22.5	27.1	5.0
P6SMB18	P6SMB18C	18	18C	14.5	16.2	19.8	1.0	26.5	22.6	5.0
P6SMB18A	P6SMB18CA	18A	18CA	15.3	17.1	18.9	1.0	25.2	24.2	5.0
P6SMB20	P6SMB20C	20	20C	16.2	18.0	22.0	1.0	29.1	20.6	5.0
P6SMB20A	P6SMB20CA	20A	20CA	17.1	19.0	21.0	1.0	27.7	22.0	5.0
P6SMB22	P6SMB22C	22	22C	17.8	19.8	24.2	1.0	31.9	18.8	5.0
P6SMB22A	P6SMB22CA	22A	22CA	18.8	20.9	23.1	1.0	30.6	19.9	5.0
P6SMB24	P6SMB24C	24	24C	19.4	21.6	26.4	1.0	34.7	17.3	5.0
P6SMB24A	P6SMB24CA	24A	24CA	20.5	22.8	25.2	1.0	33.2	18.4	5.0
P6SMB27	P6SMB27C	27	27C	21.8	24.3	29.7	1.0	39.1	15.3	5.0
P6SMB27A	P6SMB27CA	27A	27CA	23.1	25.7	28.4	1.0	37.5	16.3	5.0
P6SMB30	P6SMB30C	30	30C	24.3	27.0	33.0	1.0	43.5	13.8	5.0
P6SMB30A	P6SMB30CA	30A	30CA	25.6	28.5	31.5	1.0	41.4	14.7	5.0

※ For Bi-directional type having VRWM of 10 Volts and less, the IR limit is double

Electrical characteristics (at T =25°C unless otherwise noted)

Type Number		Marking		Reverse Stand-Off Voltage	Breakdown Voltage Min. @I _T	Breakdown Voltage Max. @ I _T	Test Current	Maximum Clamping Voltage @I _{PP}	Peak Pulse Current	Reverse Leakage @V _{RMW}
(Uni)	(Bi)	(Uni)	(Bi)	V _{RMW} (V)	V _{BR MIN} (V)	V _{BR MAX} (V)	I _T (mA)	V _C (V)	I _{PP} (A)	I _R (uA)
P6SMB33	P6SMB33C	33	33C	26.8	29.7	36.3	1.0	47.7	12.6	5.0
P6SMB33A	P6SMB33CA	33A	33CA	28.2	31.4	34.7	1.0	45.7	13.3	5.0
P6SMB36	P6SMB36C	36	36C	29.1	32.4	39.6	1.0	52.0	11.5	5.0
P6SMB36A	P6SMB36CA	36A	36CA	30.8	34.2	37.8	1.0	49.9	12.2	5.0
P6SMB39	P6SMB39C	39	39C	31.6	35.1	42.9	1.0	56.4	10.6	5.0
P6SMB39A	P6SMB39CA	39A	39CA	33.3	37.1	41.0	1.0	53.9	11.3	5.0
P6SMB43	P6SMB43C	43	43C	34.8	38.7	47.3	1.0	61.9	9.7	5.0
P6SMB43A	P6SMB43CA	43A	43CA	36.8	40.9	45.2	1.0	59.3	10.3	5.0
P6SMB47	P6SMB47C	47	47C	38.1	42.3	51.7	1.0	67.8	8.8	5.0
P6SMB47A	P6SMB47CA	47A	47CA	40.2	44.7	49.4	1.0	64.8	9.4	5.0
P6SMB51	P6SMB51C	51	51C	41.3	45.9	56.1	1.0	73.5	8.2	5.0
P6SMB51A	P6SMB51CA	51A	51CA	43.6	48.5	53.6	1.0	70.1	8.7	5.0
P6SMB56	P6SMB56C	56	56C	45.4	50.4	61.6	1.0	80.5	7.5	5.0
P6SMB56A	P6SMB56CA	56A	56CA	47.8	53.2	58.8	1.0	77.0	7.9	5.0
P6SMB62	P6SMB62C	62	62C	50.2	55.8	68.2	1.0	89.0	6.7	5.0
P6SMB62A	P6SMB62CA	62A	62CA	53.0	58.9	65.1	1.0	85.0	7.2	5.0
P6SMB68	P6SMB68C	68	68C	55.1	61.2	74.8	1.0	98.0	6.1	5.0
P6SMB68A	P6SMB68CA	68A	68CA	58.1	64.6	71.4	1.0	92.0	6.6	5.0
P6SMB75	P6SMB75C	75	75C	60.7	67.5	82.5	1.0	108	5.6	5.0
P6SMB75A	P6SMB75CA	75A	75CA	64.1	71.3	78.8	1.0	103	5.9	5.0
P6SMB82	P6SMB82C	82	82C	66.4	73.8	90.2	1.0	118	5.1	5.0
P6SMB82A	P6SMB82CA	82A	82CA	70.1	77.9	86.1	1.0	113	5.4	5.0
P6SMB91	P6SMB91C	91	91C	73.7	81.9	100	1.0	131	4.6	5.0
P6SMB91A	P6SMB91CA	91A	91CA	77.8	86.5	95.5	1.0	125	4.9	5.0
P6SMB100	P6SMB100C	100	100C	81.0	90.0	110	1.0	144	4.2	5.0
P6SMB100A	P6SMB100CA	100A	100CA	85.5	95.0	105	1.0	137	4.5	5.0
P6SMB110	P6SMB110C	110	110C	89.2	99.0	121	1.0	158	3.8	5.0
P6SMB110A	P6SMB110CA	110A	110CA	94.0	105	116	1.0	152	4.0	5.0
P6SMB120	P6SMB120C	120	120C	97.2	108	132	1.0	173	3.5	5.0
P6SMB120A	P6SMB120CA	120A	120CA	102	114	126	1.0	165	3.7	5.0
P6SMB130	P6SMB130C	130	130C	105	117	143	1.0	187	3.2	5.0
P6SMB130A	P6SMB130CA	130A	130CA	111	124	137	1.0	179	3.4	5.0
P6SMB150	P6SMB150C	150	150C	121	135	165	1.0	215	2.8	5.0
P6SMB150A	P6SMB150CA	150A	150CA	128	143	158	1.0	207	2.9	5.0
P6SMB160	P6SMB160C	160	160C	130	144	176	1.0	230	2.6	5.0
P6SMB160A	P6SMB160CA	160A	160CA	136	152	168	1.0	219	2.8	5.0

※ For Bi-directional type having VRWM of 10 Volts and less, the IR limit is double

Electrical characteristics (at T =25°C unless otherwise noted)

Type Number		Marking		Reverse Stand-Off Voltage	Breakdown Voltage Min. @I _T	Breakdown Voltage Max. @ I _T	Test Current	Maximum Clamping Voltage @I _{PP}	Peak Pulse Current	Reverse Leakage @V _{RMW}
(Uni)	(Bi)	(Uni)	(Bi)	V _{RMW} (V)	V _{BR MIN} (V)	V _{BR MAX} (V)	I _T (mA)	V _C (V)	I _{PP} (A)	I _R (uA)
P6SMB170	P6SMB170C	170	170C	138	153	187	1.0	244	2.5	5.0
P6SMB170A	P6SMB170CA	170A	170CA	145	162	179	1.0	234	2.6	5.0
P6SMB180	P6SMB180C	180	180C	146	162	198	1.0	258	2.3	5.0
P6SMB180A	P6SMB180CA	180A	180CA	154	171	189	1.0	246	2.5	5.0
P6SMB200	P6SMB200C	200	200C	162	180	220	1.0	287	2.1	5.0
P6SMB200A	P6SMB200CA	200A	200CA	171	190	210	1.0	274	2.2	5.0
P6SMB220	P6SMB220C	220	220C	175	198	242	1.0	344	1.7	5.0
P6SMB220A	P6SMB220CA	220A	220CA	185	209	231	1.0	328	1.9	5.0
P6SMB250	P6SMB250C	250	250C	202	225	275	1.0	360	1.7	5.0
P6SMB250A	P6SMB250CA	250A	250CA	214	237	263	1.0	344	1.8	5.0
P6SMB300	P6SMB300C	300	300C	243	270	330	1.0	430	1.4	5.0
P6SMB300A	P6SMB300CA	300A	300CA	256	285	315	1.0	414	1.5	5.0
P6SMB350	P6SMB350C	350	350C	284	315	385	1.0	504	1.2	5.0
P6SMB350A	P6SMB350CA	350A	350CA	300	333	368	1.0	482	1.3	5.0
P6SMB400	P6SMB400C	400	400C	324	360	440	1.0	574	1.0	5.0
P6SMB400A	P6SMB400CA	400A	400CA	342	380	420	1.0	548	1.1	5.0
P6SMB440	P6SMB440C	440	440C	356	396	484	1.0	631	0.95	5.0
P6SMB440A	P6SMB440CA	440A	440CA	376	418	462	1.0	602	1.0	5.0

※ For Bi-directional type having VRWM of 10 Volts and less, the IR limit is double

Rating and characteristic curves (P6SMB SERIES)

Fig.1 - PEAK PULSE POWER RATING CURVE

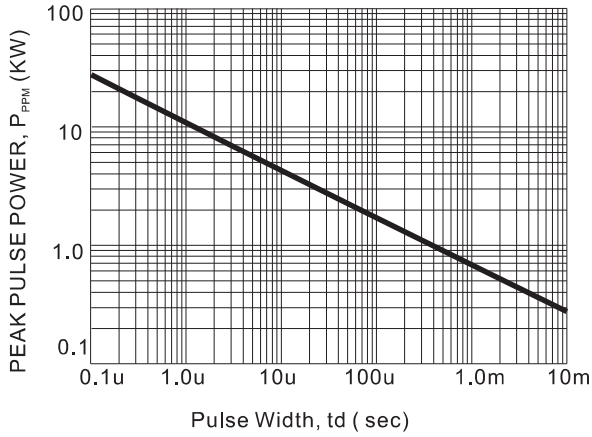

Fig.2 - PULSE DERATING CURVE

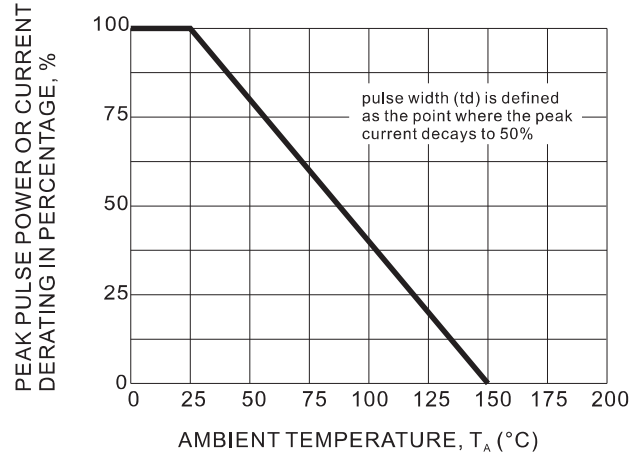

Fig.3 - PULSE WAVEFORM

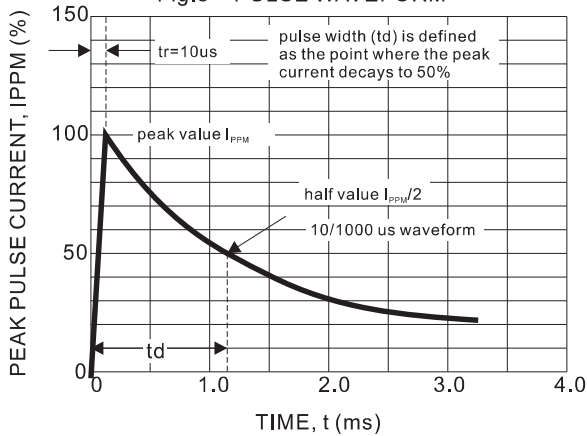

Fig.4 - TYPICAL JUNCTION CAPACITANCE

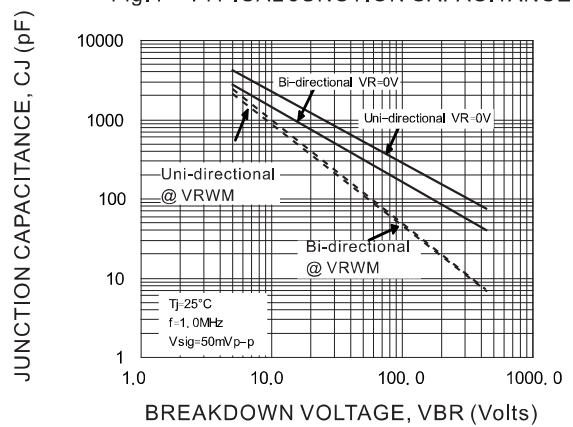

Fig.5 - STEADY STATE POWER DERATING CURVE

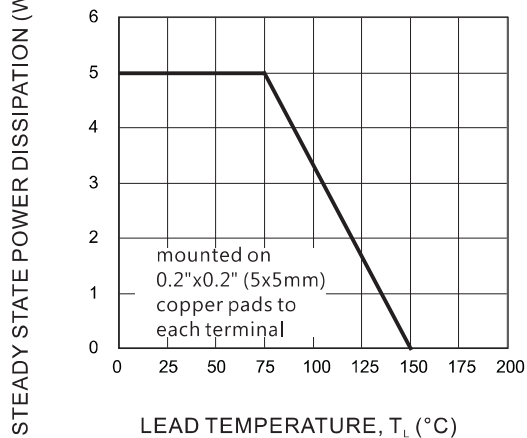
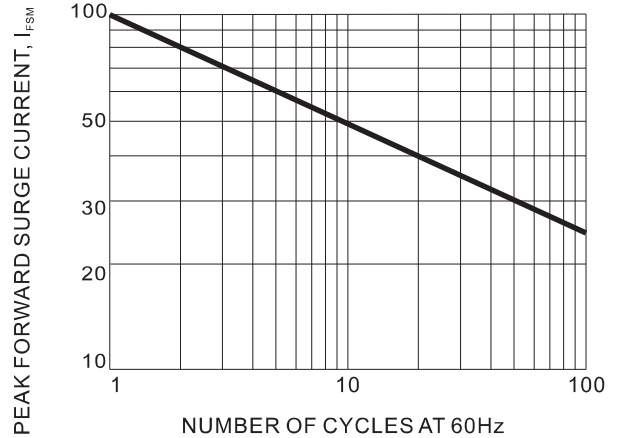





Fig.6 - MAXIMUM NON-REPETITIVE FORWARD SURGE CURRENT



Pinning information

Pin	Simplified outline	Symbol
Uni-Directional Pin1 cathode Pin2 anode		
Bi-Directional		

Marking

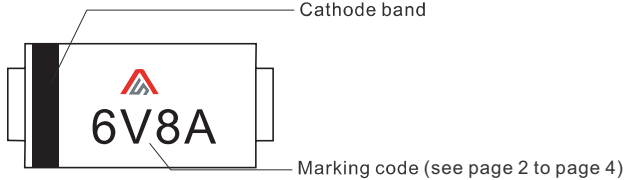
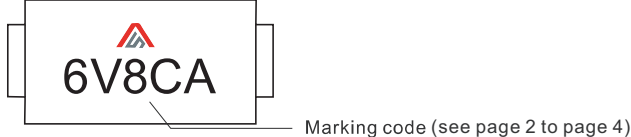
Type number	Example
Uni-Directional	 <p>Cathode band</p> <p>Marking code (see page 2 to page 4)</p>
Bi-Directional	 <p>Marking code (see page 2 to page 4)</p>

Suggested solder pad layout

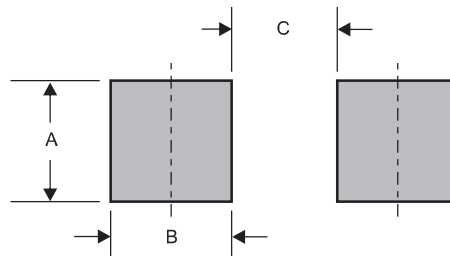

Dimensions in inches and (millimeters)

PACKAGE	A	B	C
SMB	0.090(2.30)	0.098(2.50)	0.070(1.80)