

### Features

- 400W peak pulse power capability with a 10/1000us waveform, repetition rate (duty cycle): 0.01%.
- Excellent clamping capability.
- Low incremental surge resistance.
- Fast response time from 0V to  $V_{BR}$ , typically less than 1 pS for uni-directional & 5 nS for bi-directional types.
- Ultra high-speed switching.
- Glass passivated chip junction.
- Lead-free parts meet environmental standards of MIL-STD-19500 /228
- Compliant to Halogen-free
- Suffix "-Q1" for AEC-Q101.

### Mechanical data

- Epoxy:UL94-V0 rated flame retardant
- Case : Molded plastic, DO-214AC / SMA
- Terminals : Solder plated, solderable per MIL-STD-750, Method 2026
- Polarity : Indicated by cathode band
- Mounting Position : Any

### Package outline

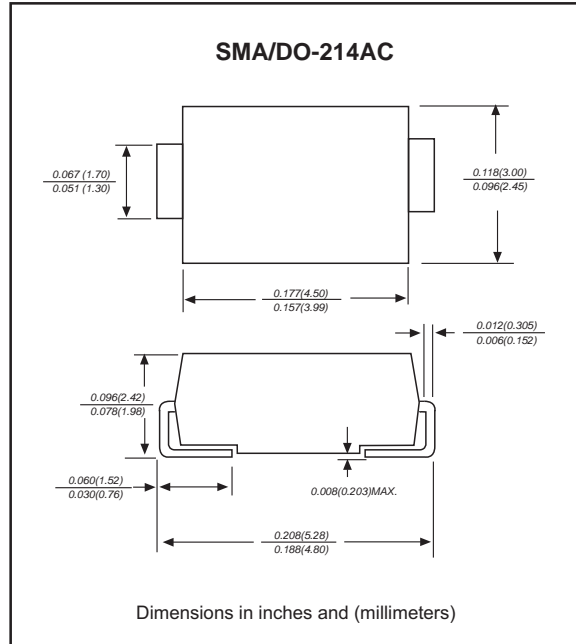

### Maximum ratings (AT $T_A=25^\circ\text{C}$ unless otherwise noted)

PARAMETER	CONDITIONS	Symbol	MIN.	TYP.	MAX.	UNIT
Peak power dissipation	with a 10/1000us waveform, Note 1 & Fig. 1	$P_{PPM}$			400	W
Peak pulse current	with a 10/1000us waveform	$I_{PPM}$	See table 1			A
Steady state power dissipation	at $T_L=75^\circ\text{C}$ lead length 0.375" (9.5 mm)	$P_{M(AV)}$			1.0	W
Peak forward surge current	8.3ms single half sine-wave superimposed on rated load (jedec method), note 2	$I_{FSM}$			40	A
Maximum instantaneous forward voltage	for uni-directional types only, at 25A, see note 3	$V_F$			3.5/5.0	V
Operating temperature		$T_J$	-55		+150	$^\circ\text{C}$
Storage temperature		$T_{STG}$	-65		+175	$^\circ\text{C}$

Note 1. Non-repetitive current pulse, per Fig. 3 and derated above  $T_A=25^\circ\text{C}$  per Fig. 2  
 2. Measured on 8.3 ms single half sine-wave or equivalent square wave, duty cycle=4 pulses per minute maximum  
 3.  $V_F=3.5\text{V}$  max. for devices of  $V_{BR}<200\text{V}$ , and  $V_F=5.0\text{V}$  max. for devices of  $V_{BR}>201\text{V}$

### Electrical characteristics (at T =25°C unless otherwise noted)

Type Number		Marking		Reverse Stand-Off Voltage	Breakdown Voltage Min. @I <sub>T</sub>	Breakdown Voltage Max. @ I <sub>T</sub>	Test Current	Maximum Clamping Voltage @I <sub>PP</sub>	Peak Pulse Current	Reverse Leakage @V <sub>RMW</sub>
(Uni)	(Bi)	(Uni)	(Bi)	V <sub>RMW</sub> (V)	V <sub>BR MIN</sub> (V)	V <sub>BR MAX</sub> (V)	I <sub>T</sub> (mA)	V <sub>C</sub> (V)	I <sub>PP</sub> (A)	I <sub>R</sub> (uA)
P4SMA6.8-Q1	P4SMA6.8C-Q1	6V8	6V8C	5.50	6.12	7.48	10	10.8	38.0	1000.0
P4SMA6.8A-Q1	P4SMA6.8CA-Q1	6V8A	6V8CA	5.80	6.45	7.14	10	10.5	40.0	1000.0
P4SMA7.5-Q1	P4SMA7.5C-Q1	7V5	7V5C	6.05	6.75	8.25	10	11.7	36.0	500.0
P4SMA7.5A-Q1	P4SMA7.5CA-Q1	7V5A	7V5CA	6.40	7.13	7.88	10	11.3	37.0	500.0
P4SMA8.2-Q1	P4SMA8.2C-Q1	8V2	8V2C	6.63	7.38	9.02	10	12.5	33.0	200.0
P4SMA8.2A-Q1	P4SMA8.2CA-Q1	8V2A	8V2CA	7.02	7.79	8.61	10	12.1	35.0	200.0
P4SMA9.1-Q1	P4SMA9.1C-Q1	9V1	9V1C	7.37	8.19	10.0	1.0	13.8	30.0	50.0
P4SMA9.1A-Q1	P4SMA9.1CA-Q1	9V1A	9V1CA	7.78	8.65	9.55	1.0	13.4	31.0	50.0
P4SMA10-Q1	P4SMA10C-Q1	10	10C	8.10	9.00	11.0	1.0	15.0	28.0	10.0
P4SMA10A-Q1	P4SMA10CA-Q1	10A	10CA	8.55	9.50	10.5	1.0	14.5	29.0	10.0
P4SMA11-Q1	P4SMA11C-Q1	11	11C	8.92	9.90	12.1	1.0	16.2	26.0	5.0
P4SMA11A-Q1	P4SMA11CA-Q1	11A	11CA	9.40	10.5	11.6	1.0	15.6	27.0	5.0
P4SMA12-Q1	P4SMA12C-Q1	12	12C	9.72	10.8	13.2	1.0	17.3	24.0	5.0
P4SMA12A-Q1	P4SMA12CA-Q1	12A	12CA	10.2	11.4	12.6	1.0	16.7	25.0	5.0
P4SMA13-Q1	P4SMA13C-Q1	13	13C	10.5	11.7	14.3	1.0	19.0	22.0	5.0
P4SMA13A-Q1	P4SMA13CA-Q1	13A	13CA	11.1	12.4	13.7	1.0	18.2	23.0	5.0
P4SMA15-Q1	P4SMA15C-Q1	15	15C	12.1	13.5	16.5	1.0	22.0	19.0	5.0
P4SMA15A-Q1	P4SMA15CA-Q1	15A	15CA	12.8	14.3	15.8	1.0	21.2	20.0	5.0
P4SMA16-Q1	P4SMA16C-Q1	16	16C	12.9	14.4	17.6	1.0	23.5	18.0	5.0
P4SMA16A-Q1	P4SMA16CA-Q1	16A	16CA	13.6	15.2	16.8	1.0	22.5	19.0	5.0
P4SMA18-Q1	P4SMA18C-Q1	18	18C	14.5	16.2	19.8	1.0	26.5	16.0	5.0
P4SMA18A-Q1	P4SMA18CA-Q1	18A	18CA	15.3	17.1	18.9	1.0	25.2	17.0	5.0
P4SMA20-Q1	P4SMA20C-Q1	20	20C	16.2	18.0	22.0	1.0	29.1	14.0	5.0
P4SMA20A-Q1	P4SMA20CA-Q1	20A	20CA	17.1	19.0	21.0	1.0	27.7	15.0	5.0
P4SMA22-Q1	P4SMA22C-Q1	22	22C	17.8	19.8	24.2	1.0	31.9	13.0	5.0
P4SMA22A-Q1	P4SMA22CA-Q1	22A	22CA	18.8	20.9	23.1	1.0	30.6	14.0	5.0
P4SMA24-Q1	P4SMA24C-Q1	24	24C	19.4	21.6	26.4	1.0	34.7	12.0	5.0
P4SMA24A-Q1	P4SMA24CA-Q1	24A	24CA	20.5	22.8	25.2	1.0	33.2	13.0	5.0
P4SMA27-Q1	P4SMA27C-Q1	27	27C	21.8	24.3	29.7	1.0	39.1	11.0	5.0
P4SMA27A-Q1	P4SMA27CA-Q1	27A	27CA	23.1	25.7	28.4	1.0	37.5	11.2	5.0
P4SMA30-Q1	P4SMA30C-Q1	30	30C	24.3	27.0	33.0	1.0	43.5	10.0	5.0
P4SMA30A-Q1	P4SMA30CA-Q1	30A	30CA	25.6	28.5	31.5	1.0	41.4	10.0	5.0
P4SMA33-Q1	P4SMA33C-Q1	33	33C	26.8	29.7	36.3	1.0	47.7	9.0	5.0
P4SMA33A-Q1	P4SMA33CA-Q1	33A	33CA	28.2	31.4	34.7	1.0	45.7	9.0	5.0
P4SMA36-Q1	P4SMA36C-Q1	36	36C	29.1	32.4	39.6	1.0	52.0	8.0	5.0
P4SMA36A-Q1	P4SMA36CA-Q1	36A	36CA	30.8	34.2	37.8	1.0	49.9	8.4	5.0

※ For Bi-directional type having VRWM of 10 Volts and less, the IR limit is double

### Electrical characteristics (at T =25°C unless otherwise noted)

Type Number		Marking		Reverse Stand-Off Voltage	Breakdown Voltage Min. @I <sub>T</sub>	Breakdown Voltage Max. @ I <sub>T</sub>	Test Current	Maximum Clamping Voltage @I <sub>PP</sub>	Peak Pulse Current	Reverse Leakage @V <sub>RMW</sub>
(Uni)	(Bi)	(Uni)	(Bi)	V <sub>RMW</sub> (V)	V <sub>BR MIN</sub> (V)	V <sub>BR MAX</sub> (V)	I <sub>T</sub> (mA)	V <sub>C</sub> (V)	I <sub>PP</sub> (A)	I <sub>R</sub> ( $\mu$ A)
P4SMA39-Q1	P4SMA39C-Q1	39	39C	31.6	35.1	42.9	1.0	56.4	7.4	5.0
P4SMA39A-Q1	P4SMA39CA-Q1	39A	39CA	33.3	37.1	41.0	1.0	53.9	7.8	5.0
P4SMA43-Q1	P4SMA43C-Q1	43	43C	34.8	38.7	47.3	1.0	61.9	6.8	5.0
P4SMA43A-Q1	P4SMA43CA-Q1	43A	43CA	36.8	40.9	45.2	1.0	59.3	7.1	5.0
P4SMA47-Q1	P4SMA47C-Q1	47	47C	38.1	42.3	51.7	1.0	67.8	6.2	5.0
P4SMA47A-Q1	P4SMA47CA-Q1	47A	47CA	40.2	44.7	49.4	1.0	64.8	5.0	5.0
P4SMA51-Q1	P4SMA51C-Q1	51	51C	41.3	45.9	56.1	1.0	73.5	5.7	5.0
P4SMA51A-Q1	P4SMA51CA-Q1	51A	51CA	43.6	48.5	53.6	1.0	70.1	6.0	5.0
P4SMA56-Q1	P4SMA56C-Q1	56	56C	45.4	50.4	61.6	1.0	80.5	5.2	5.0
P4SMA56A-Q1	P4SMA56CA-Q1	56A	56CA	47.8	53.2	58.8	1.0	77.0	5.5	5.0
P4SMA62-Q1	P4SMA62C-Q1	62	62C	50.2	55.8	68.2	1.0	89.0	4.7	5.0
P4SMA62A-Q1	P4SMA62CA-Q1	62A	62CA	53.0	58.9	65.1	1.0	85.0	5.0	5.0
P4SMA68-Q1	P4SMA68C-Q1	68	68C	55.1	61.2	74.8	1.0	98.0	4.3	5.0
P4SMA68A-Q1	P4SMA68CA-Q1	68A	68CA	58.1	64.6	71.4	1.0	92.0	4.6	5.0
P4SMA75-Q1	P4SMA75C-Q1	75	75C	60.7	67.5	82.5	1.0	108	3.9	5.0
P4SMA75A-Q1	P4SMA75CA-Q1	75A	75CA	64.1	71.3	78.8	1.0	103	4.1	5.0
P4SMA82-Q1	P4SMA82C-Q1	82	82C	66.4	73.8	90.2	1.0	118	3.6	5.0
P4SMA82A-Q1	P4SMA82CA-Q1	82A	82CA	70.1	77.9	86.1	1.0	113	3.7	5.0
P4SMA91-Q1	P4SMA91C-Q1	91	91C	73.7	81.9	100	1.0	131	3.2	5.0
P4SMA91A-Q1	P4SMA91CA-Q1	91A	91CA	77.8	86.5	95.5	1.0	125	3.4	5.0
P4SMA100-Q1	P4SMA100C-Q1	100	100C	81.0	90.0	110	1.0	144	2.9	5.0
P4SMA100A-Q1	P4SMA100CA-Q1	100A	100CA	85.5	95.0	105	1.0	137	3.1	5.0
P4SMA110-Q1	P4SMA110C-Q1	110	110C	89.2	99.0	121	1.0	158	2.7	5.0
P4SMA110A-Q1	P4SMA110CA-Q1	110A	110CA	94.0	105	116	1.0	152	2.8	5.0
P4SMA120-Q1	P4SMA120C-Q1	120	120C	97.2	108	132	1.0	173	2.4	5.0
P4SMA120A-Q1	P4SMA120CA-Q1	120A	120CA	102	114	126	1.0	165	2.5	5.0
P4SMA130-Q1	P4SMA130C-Q1	130	130C	105	117	143	1.0	187	2.2	5.0
P4SMA130A-Q1	P4SMA130CA-Q1	130A	130CA	111	124	137	1.0	179	2.3	5.0
P4SMA150-Q1	P4SMA150C-Q1	150	150C	121	135	165	1.0	215	2.0	5.0
P4SMA150A-Q1	P4SMA150CA-Q1	150A	150CA	128	143	158	1.0	207	2.0	5.0
P4SMA160-Q1	P4SMA160C-Q1	160	160C	130	144	176	1.0	230	1.8	5.0
P4SMA160A-Q1	P4SMA160CA-Q1	160A	160CA	136	152	168	1.0	219	1.9	5.0

※ For Bi-directional type having VRWM of 10 Volts and less, the IR limit is double

### Electrical characteristics (at T =25°C unless otherwise noted)

Type Number		Marking		Reverse Stand-Off Voltage	Breakdown Voltage Min. @I <sub>T</sub>	Breakdown Voltage Max. @ I <sub>T</sub>	Test Current	Maximum Clamping Voltage @I <sub>PP</sub>	Peak Pulse Current	Reverse Leakage @V <sub>RMW</sub>
(Uni)	(Bi)	(Uni)	(Bi)	V <sub>RMW</sub> (V)	V <sub>BR MIN</sub> (V)	V <sub>BR MAX</sub> (V)	I <sub>T</sub> (mA)	V <sub>C</sub> (V)	I <sub>PP</sub> (A)	I <sub>R</sub> (uA)
P4SMA170-Q1	P4SMA170C-Q1	170	170C	138	153	187	1.0	244	1.7	5.0
P4SMA170A-Q1	P4SMA170CA-Q1	170A	170CA	145	162	179	1.0	234	1.8	5.0
P4SMA180-Q1	P4SMA180C-Q1	180	180C	146	162	198	1.0	258	1.6	5.0
P4SMA180A-Q1	P4SMA180CA-Q1	180A	180CA	154	171	189	1.0	246	1.7	5.0
P4SMA200-Q1	P4SMA200C-Q1	200	200C	162	180	220	1.0	287	1.5	5.0
P4SMA200A-Q1	P4SMA200CA-Q1	200A	200CA	171	190	210	1.0	274	1.53	5.0
P4SMA220-Q1	P4SMA220C-Q1	220	220C	175	198	242	1.0	344	1.16	5.0
P4SMA220A-Q1	P4SMA220CA-Q1	220A	220CA	185	209	231	1.0	328	1.22	5.0
P4SMA250-Q1	P4SMA250C-Q1	250	250C	202	225	275	1.0	360	1.1	5.0
P4SMA250A-Q1	P4SMA250CA-Q1	250A	250CA	214	237	263	1.0	344	1.16	5.0
P4SMA300-Q1	P4SMA300C-Q1	300	300C	243	270	330	1.0	430	0.93	5.0
P4SMA300A-Q1	P4SMA300CA-Q1	300A	300CA	256	285	315	1.0	414	0.97	5.0
P4SMA350-Q1	P4SMA350C-Q1	350	350C	284	315	385	1.0	504	0.79	5.0
P4SMA350A-Q1	P4SMA350CA-Q1	350A	350CA	300	333	368	1.0	482	0.83	5.0
P4SMA400-Q1	P4SMA400C-Q1	400	400C	324	360	440	1.0	574	0.70	5.0
P4SMA400A-Q1	P4SMA400CA-Q1	400A	400CA	342	380	420	1.0	548	0.73	5.0
P4SMA440-Q1	P4SMA440C-Q1	440	440C	356	396	484	1.0	631	0.63	5.0
P4SMA440A-Q1	P4SMA440CA-Q1	440A	440CA	376	418	462	1.0	602	0.65	5.0

※ For Bi-directional type having VRWM of 10 Volts and less, the IR limit is double

## Rating and characteristic curves (P4SMA-Q1 SERIES)

Fig.1 - PEAK PULSE POWER RATING CURVE

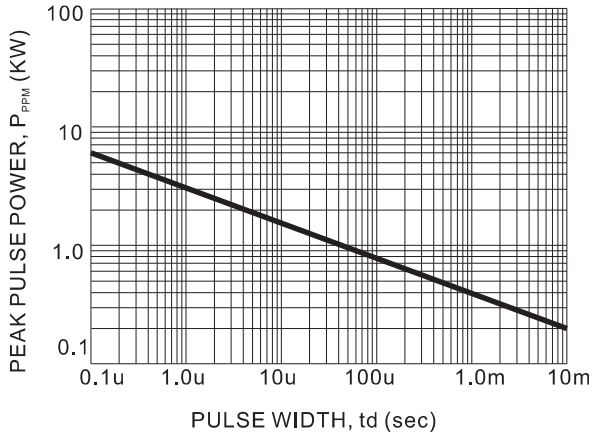

Fig.2 - PULSE DERATING CURVE

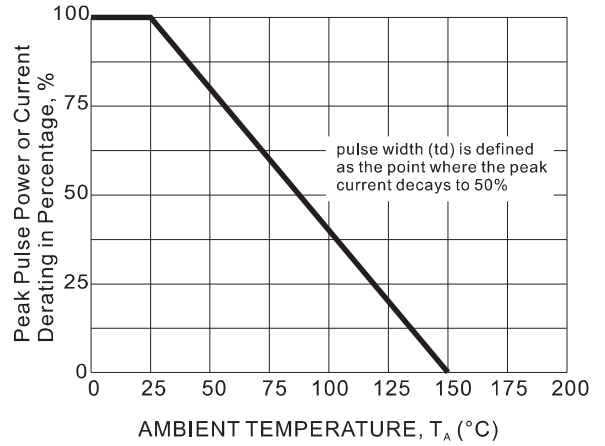

Fig.3 - Pulse Waveform

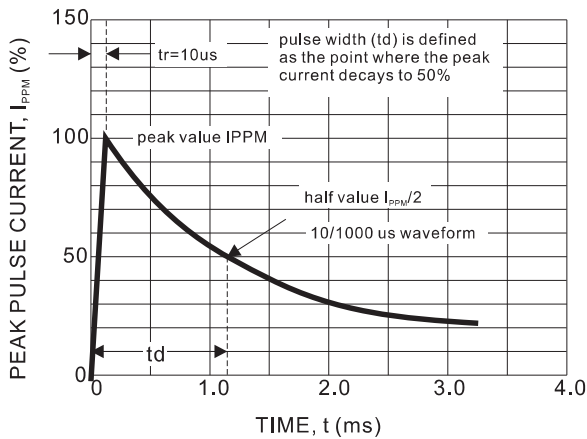

Fig.4 - Typical Junction Capacitance

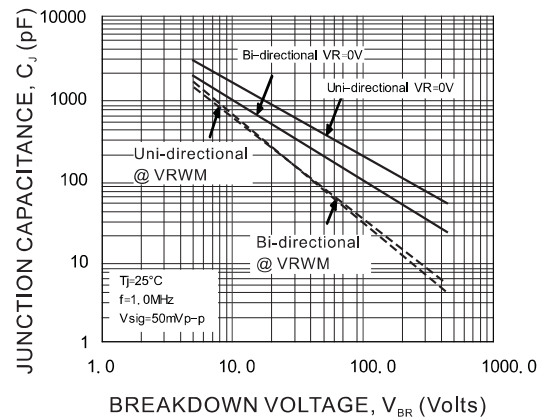

Fig.5 - STEADY STATE POWER DERATING CURVE

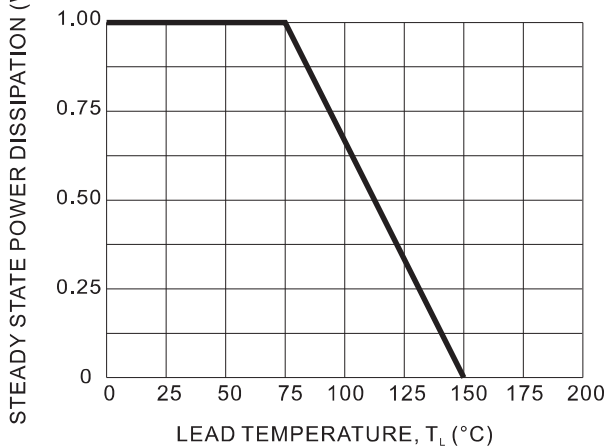
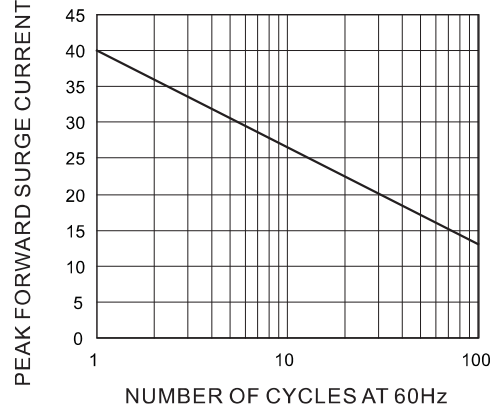





Fig.6 - MAXIMUM NON-REPETITIVE FORWARD SURGE CURRENT



### Pinning information

Pin	Simplified outline	Symbol
Uni-Directional Pin1 cathode Pin2 anode		
Bi-Directional		

### Marking

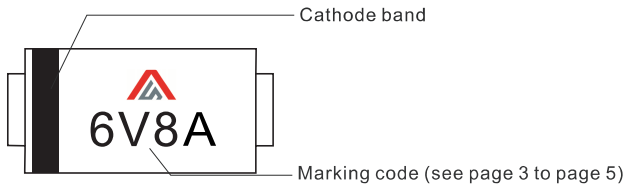
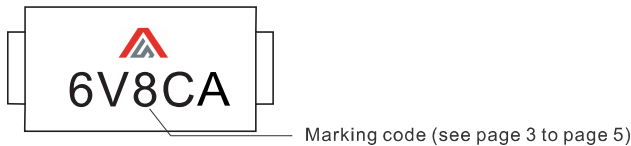
Type number	Example
Uni-Directional	
Bi-Directional	

### Suggested solder pad layout

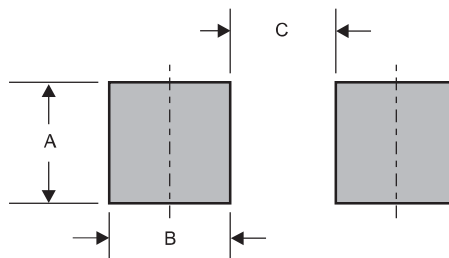

Dimensions in inches and (millimeters)

PACKAGE	A	B	C
SMA	0.063 (1.60)	0.059 (1.50)	0.110 (2.80)