

Features

- Dual rectifier construction, positive centetap, offer 10.0A Half wave and 20.0A full wave rectification.
- High surge current capability.
- Super fast recovery time for switching mode application.
- Low power loss.
- Glass passivated chip junctions.
- Lead-free parts meet environmental standards of MIL-STD-19500/228

Mechanical data

- Epoxy : UL94-V0 rated flame retardant
- Case : JEDEC ITO-220AB molded plastic body over passivated chip
- Lead : Axial leads, solderable per MIL-STD-202, Method 208 guranteed
- Polarity: As marked
- Mounting Position : Any

Package outline

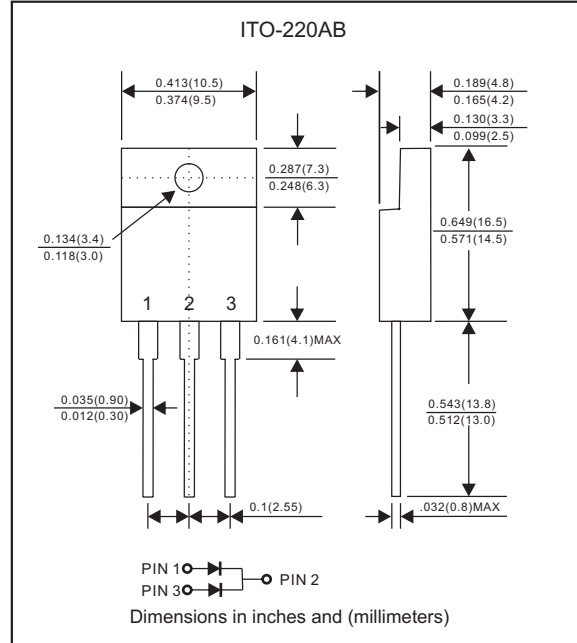

Maximum ratings (AT $T_A=25^{\circ}\text{C}$ unless otherwise noted)

PARAMETER	SYMBOLS	MUR2020FCT	MUR2040FCT	MUR2060FCT	UNIT
Maximum repetitive peak reverse voltage	V_{RRM}	200	400	600	V
Maximum RMS voltage	V_{RMS}	140	280	420	V
Maximum DC blocking voltage	V_{DC}	200	400	600	V
Maximum average forward rectified current	I_o	20			A
Peak forward surge current 8.3ms single half sine-wave(JEDEC method)	I_{FSM}	125			A
Operating junction temperature range	T_J	-55 to +150			$^{\circ}\text{C}$
Storage temperature range	T_{STG}	-65 to +175			$^{\circ}\text{C}$

Electrical Characteristics (AT $T_A=25^{\circ}\text{C}$ unless otherwise noted)

PARAMETER	SYMBOLS	MUR2020FCT	MUR2040FCT	MUR2060FCT	UNIT
Maximum forward voltage per leg at $I_F=10\text{A}$	V_F	0.98	1.30	1.70	V
Maximum reverse recovery time per leg (Note 1)	t_{rr}	25	50		ns
Maximum DC reverse current at $T_J=25^{\circ}\text{C}$ at rated DC blocking voltage per leg at $T_J=125^{\circ}\text{C}$	I_R	5.0 500			μA μA

Thermal Characteristics

PARAMETER	SYMBOLS	MUR2020FCT	MUR2040FCT	MUR2060FCT	UNIT
Typical thermal resistance junction to case per leg	$R_{\theta JC}$	2.0			$^{\circ}\text{C}/\text{W}$

Note 1: Reverse recovery time test condition, $I_F=0.5\text{A}$, $I_R=1.0\text{A}$, $I_{RR}=0.25\text{A}$

Rating and characteristic curves(MUR2020FCT THRU MUR2060FCT)

FIG.1-TYPICAL FORWARD CURRENT DERATING CURVE

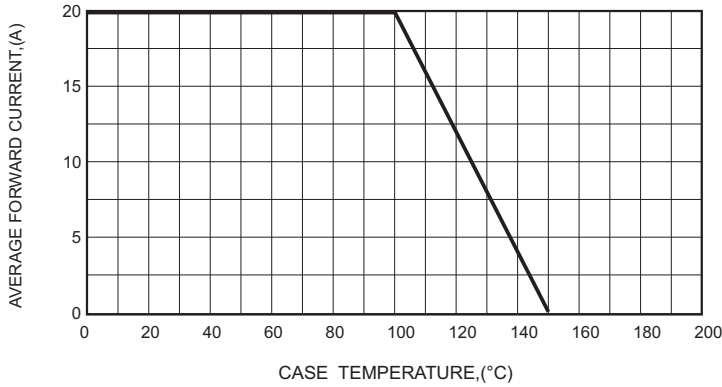

FIG.2-TYPICAL FORWARD CHARACTERISTICS

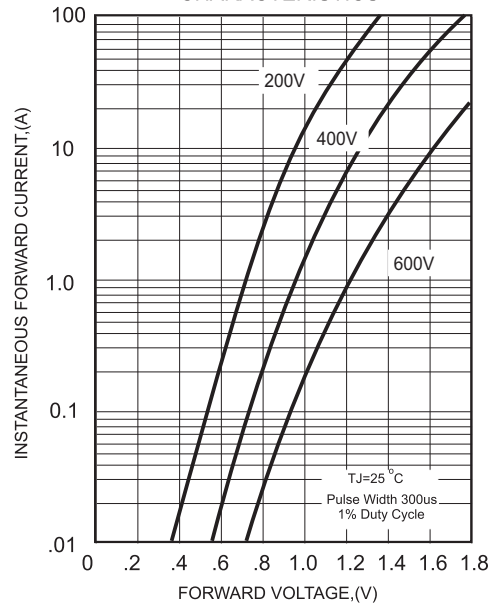

FIG.3-MAXIMUM NON-REPETITIVE FORWARD SURGE CURRENT

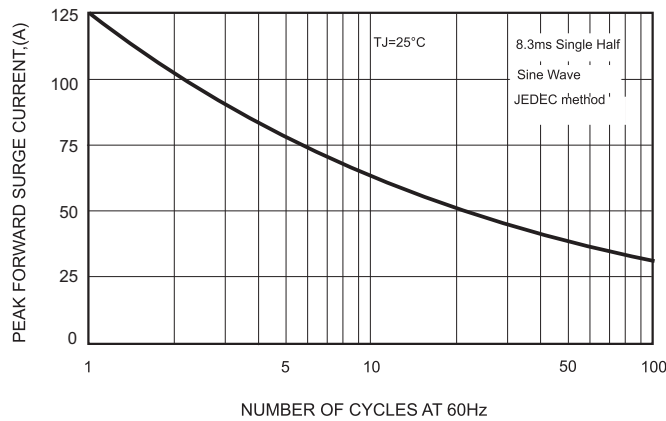

FIG.4 - TYPICAL REVERSE CHARACTERISTICS

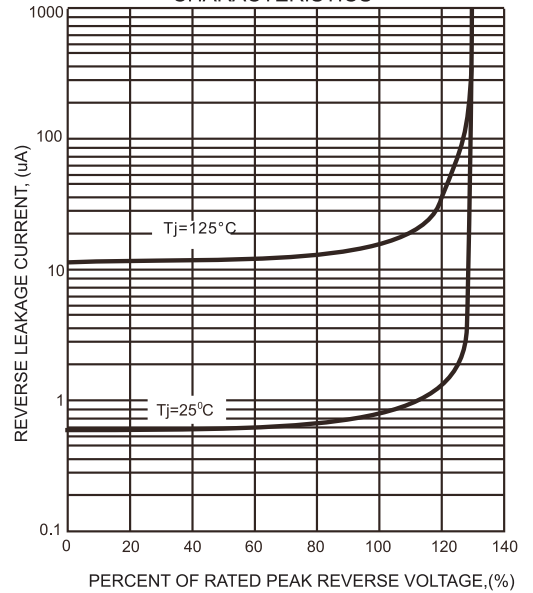
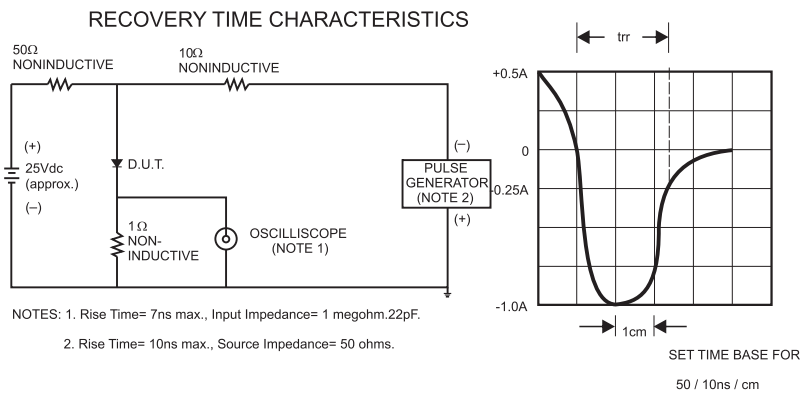
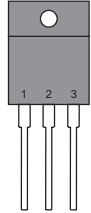
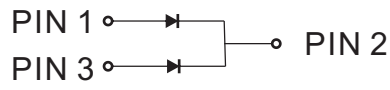

FIG.5- TEST CIRCUIT DIAGRAM AND REVERSE RECOVERY TIME CHARACTERISTICS



Pinning information

Pin	Simplified outline	Symbol
Pin1 anode Pin2 cathode Pin3 anode		

Marking

Type number	Marking code
MUR2020FCT	MUR2020FCT
MUR2040FCT	MUR2040FCT
MUR2060FCT	MUR2060FCT