

Features

- Batch process design, excellent power dissipation offers better reverse leakage current and thermal resistance.
- Low power loss, high efficiency.
- High current capability, low forward voltage drop.
- High surge capability.
- Guardring for overvoltage protection.
- Ultra high-speed switching.
- Silicon epitaxial planar chip, metal silicon junction.
- Lead-free parts meet environmental standards of MIL-STD-19500 /228
- Compliant to Halogen-free

Mechanical data

- Epoxy:UL94-V0 rated flame retardant
- Case : Molded plastic, TO-263AB / D2PAK
- Terminals : Solder plated, solderable per MIL-STD-750, Method 2026
- Mounting Position : Any

Package outline

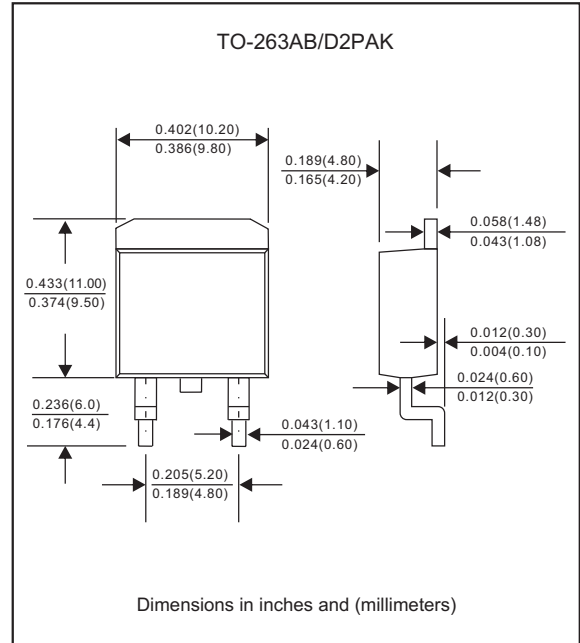

Maximum ratings and Electrical Characteristics (AT $T_A=25^\circ\text{C}$ unless otherwise noted)

PARAMETER	CONDITIONS	Symbol	MIN.	TYP.	MAX.	UNIT
Forward rectified current	See Fig.1	I_o			10.0	A
Forward surge current	8.3ms single half sine-wave (JEDEC methode)	I_{FSM}			120	A
Reverse current	$V_R = V_{RRM} T_J = 25^\circ\text{C}$	I_R			0.05	mA
	$V_R = V_{RRM} T_J = 125^\circ\text{C}$				10	
Thermal resistance	Junction to case	$R_{\theta JC}$		3.0		$^\circ\text{C}/\text{W}$
Storage temperature		T_{STG}	-65		+175	$^\circ\text{C}$

SYMBOLS	V_{RRM}^{*1} (V)	V_{RMS}^{*2} (V)	V_R^{*3} (V)	V_F^{*4} (V)	Operating temperature T_J , ($^\circ\text{C}$)
MBR1040CG	40	28	40	0.70	-55 to +150
MBR1045CG	45	31.5	45		
MBR1050CG	50	35	50	0.80	
MBR1060CG	60	42	60		
MBR1080CG	80	56	80	0.85	
MBR10100CG	100	70	100		
MBR10150CG	150	105	150	0.92	-55 to +175
MBR10200CG	200	140	200		

*1 Repetitive peak reverse voltage

*2 RMS voltage

*3 Continuous reverse voltage

*4 Maximum forward voltage
IF = 5.0A, 25 $^\circ\text{C}$

Rating and characteristic curves (MBR1040CG THRU MBR10200CG)

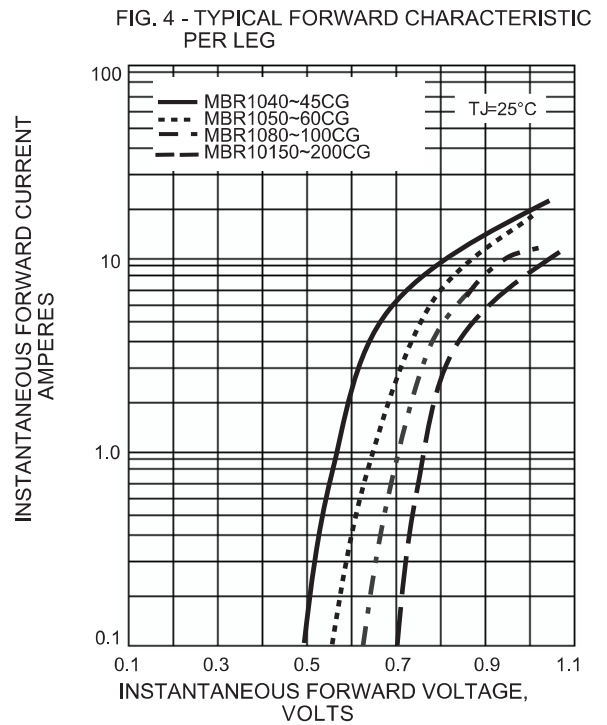
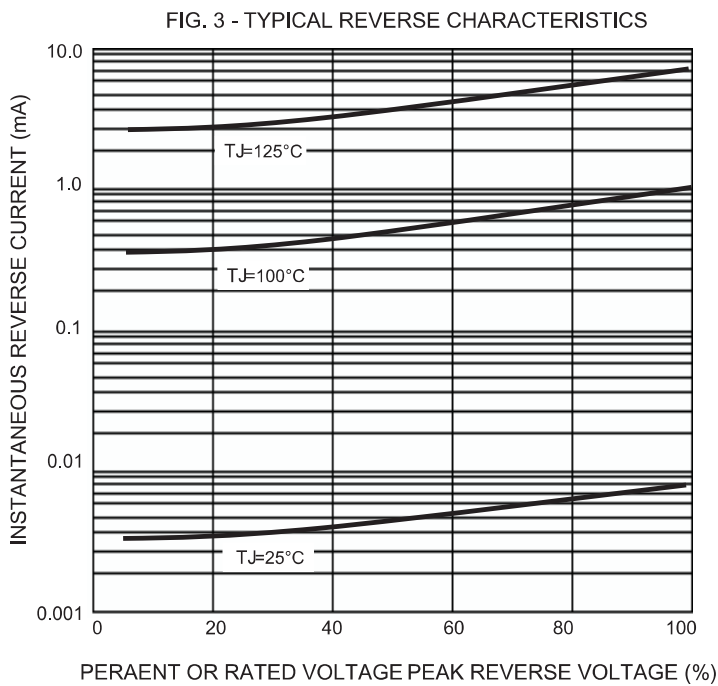
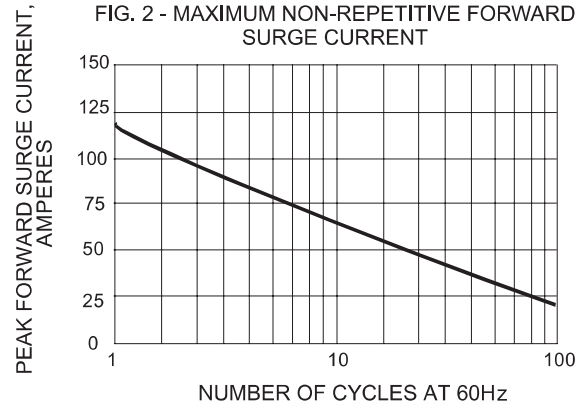
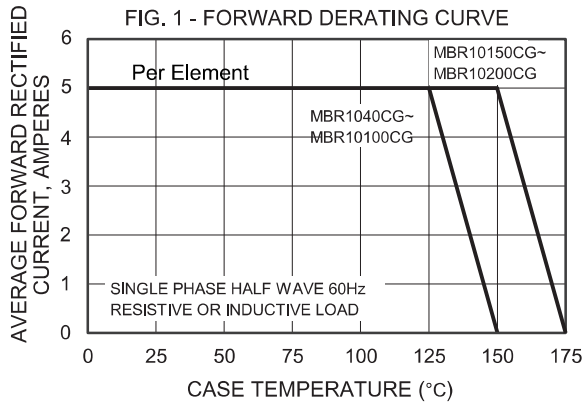

Pinning information

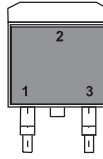
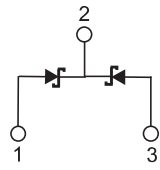
Pin	Simplified outline	Symbol
Pin1 anode Pin2 cathode Pin3 anode		

Marking

Type number	Marking code
MBR1040CG	MBR1040CG
MBR1045CG	MBR1045CG
MBR1050CG	MBR1050CG
MBR1060CG	MBR1060CG
MBR1080CG	MBR1080CG
MBR10100CG	MBR10100CG
MBR10150CG	MBR10150CG
MBR10200CG	MBR10200CG

Suggested solder pad layout

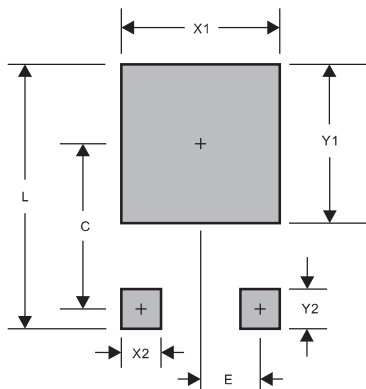

PACKAGE	D2PAK
C	0.374(9.50)
E	0.098(2.50)
L	0.665(16.90)
X1	0.425(10.80)
X2	0.071(1.80)
Y1	0.449(11.40)
Y2	0.138(3.50)

Dimensions in inches and (millimeters)