

Features

- Surge overload ratings to 60 amperes peak
- Ideal for printed circuit board
- Reliable low cost construction technique
- Lead-free parts for green partner, meet RoHS requirements
- Suffix "-H" indicates Halogen free parts, ex. D2UB100-H.

Mechanical data

- Case: Potted plastic round body D3K
- Epoxy: UL94-V0 rated flame retardant
- Terminals: Solderable per MIL-STD-750 Method 2026
- Polarity: As marked
- Mounting Position: Any

Package outline

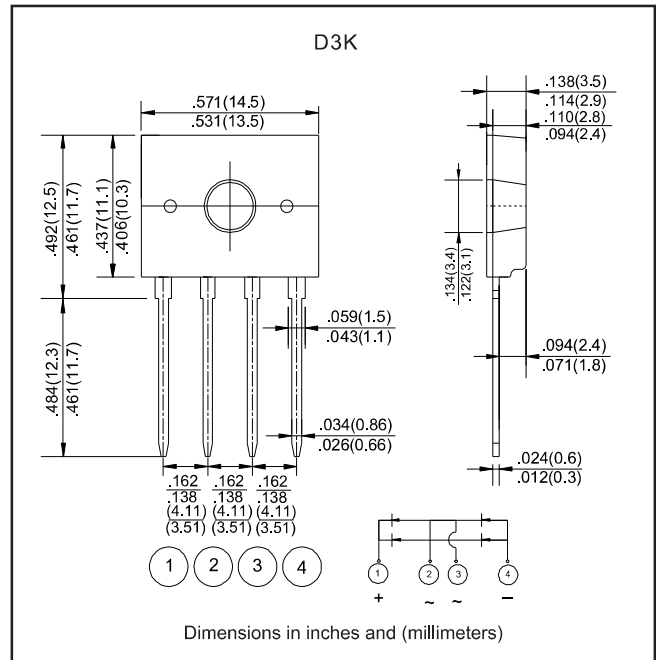

Maximum ratings and Electrical Characteristics (AT $T_A=25^\circ\text{C}$ unless otherwise noted)

PARAMETER	CONDITIONS	Symbol	MIN.	TYP.	MAX.	UNIT
Forward rectified current	See Fig.1	I_o			2.0	A
Forward surge current	8.3ms single half sine-wave (JEDEC methode)	I_{FSM}			60	A
Reverse current	$V_R = V_{RRM} T_J = 25^\circ\text{C}$	I_R			5.0	uA
	$V_R = V_{RRM} T_J = 125^\circ\text{C}$				500	
I^2t Rating for fusing	$t < 8.3 \text{ ms}$	I^2t			15	A^2s
Typical thermal resistance	Junction to case(with heatsink)	$R_{\theta JC}$		1.5		$^\circ\text{C}/\text{W}$
Storage temperature		T_{STG}	-65		+175	$^\circ\text{C}$

SYMBOLS	V_{RRM}^{*1} (V)	V_{RMS}^{*2} (V)	V_R^{*3} (V)	V_F^{*4} (V)	Operating temperature T_J , ($^\circ\text{C}$)
D2UB05	50	35	50	1.0	-55 to +150
D2UB10	100	70	100		
D2UB20	200	140	200		
D2UB40	400	280	400		
D2UB60	600	420	600		
D2UB80	800	560	800		
D2UB100	1000	700	1000		

*1 Repetitive peak reverse voltage

*2 RMS voltage

*3 Continuous reverse voltage

*4 Maximum forward voltage @ $I_F=2.0\text{A}$

Rating and characteristic curves (D2UB05 THRU D2UB100)

FIG.1-DERATING CURVE
OUTPUT RECTIFIED CURRENT

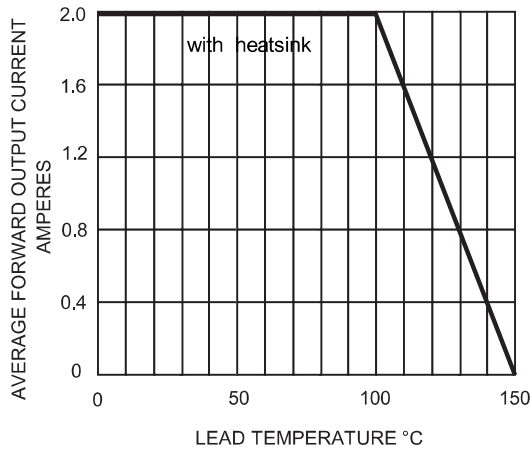

FIG.2-TYPICAL FORWARD CHARACTERISTICS

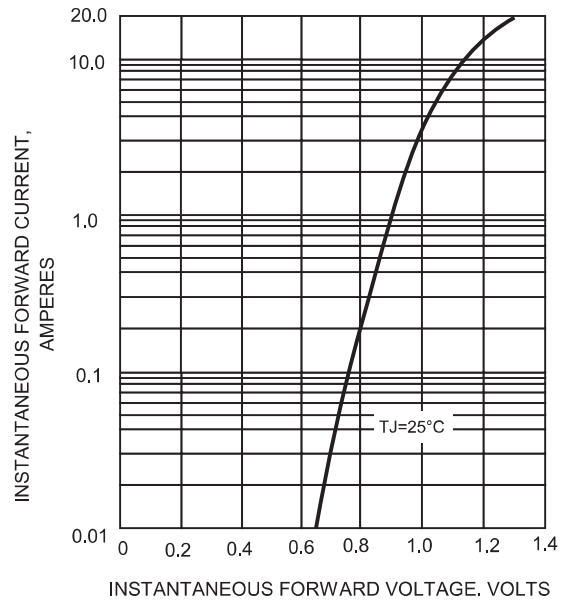

FIG.3-TYPICAL REVERSE CHARACTERISTICS

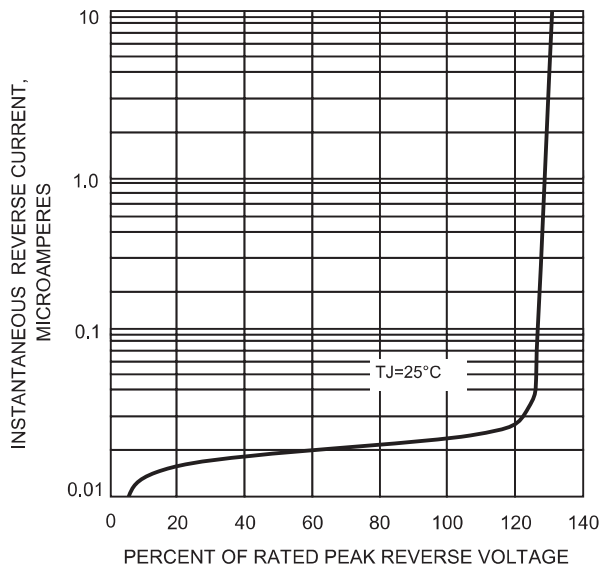
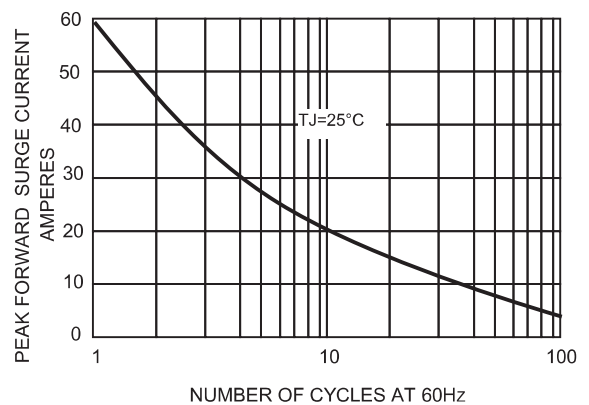
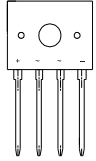
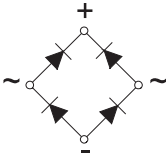

FIG.4-MAXIMUM FORWARD SURGE CURRENT



Pinning information

Simplified outline	Symbol
	

Marking

Type number	Marking code
D2UB05	D2UB05
D2UB10	D2UB10
D2UB20	D2UB20
D2UB40	D2UB40
D2UB60	D2UB60
D2UB80	D2UB80
D2UB100	D2UB100