

Product Summary

$V_{(BR)DSS}$	$R_{DS(on)MAX}$	I_D
650V	109mΩ@10V	38A

Feature

- Optimized body diode reverse recovery performance
- Low on-resistance and low conduction losses
- Small package
- Ultra Low Gate Charge cause lower driving requirements

Application

- Power factor correction (PFC)
- Switched mode power supplies(SMPS)
- Uninterruptible Power Supply (UPS)
- LLC Half-bridge

Package

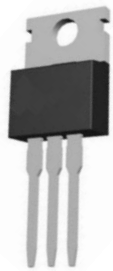

TO-220AB

Circuit diagram

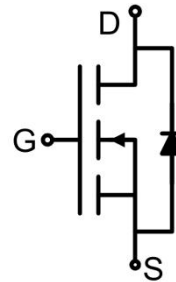

Marking

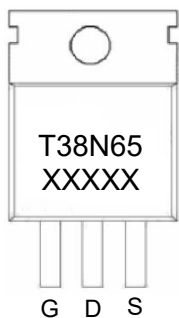

Absolute maximum ratings (T_C=25°C unless otherwise noted)

Parameter	Symbol	Value	Unit
Drain-Source Voltage	V _{DS}	650	V
Gate-Source Voltage	V _{GS}	±40	V
Continuous Drain Current	I _D	38	A
Continuous Drain Current(T _C =100°C)	I _D (100°C)	24	A
Pulsed Drain Current ¹⁾	I _{DM}	152	A
Power Dissipation	P _D	322	W
Thermal Resistance,Junction-to-Case	R _{θJC}	0.39	°C/W
Single pulse avalanche energy ²⁾	E _{AS}	841	mJ
Junction Temperature	T _J	150	°C
Storage Temperature	T _{STG}	-55 ~ +150	°C

Electrical characteristics (T_A=25 °C unless otherwise noted)

Parameter	Symbol	Test Condition	Min.	Typ.	Max.	Unit
Static Characteristics						
Drain-source breakdown voltage	V _{(BR)DSS}	V _{GS} = 0V, I _D = 500μA	650			V
Zero gate voltage drain current	I _{DSS}	V _{DS} = 650V, V _{GS} = 0V			3	μA
Gate-body leakage current	I _{GSS}	V _{GS} = ±20V, V _{DS} = 0V			±100	nA
Gate threshold voltage	V _{GS(th)}	V _{DS} = V _{GS} , I _D = 250μA	2.6	3.5	4.3	V
Drain-source on-resistance	R _{DS(on)}	V _{GS} = 10V, I _D = 19A		89	109	mΩ
Dynamic characteristics³⁾						
Input Capacitance	C _{iss}	V _{DS} = 50V, V _{GS} = 0V, f = 1.0MHz		2800		pF
Output Capacitance	C _{oss}			97		
Reverse Transfer Capacitance	C _{rss}			1.5		
Total Gate Charge	Q _g	V _{DS} = 480V, V _{GS} = 10V, I _D = 38A		45		nC
Gate-Source Charge	Q _{gs}			15		
Gate-Drain Charge	Q _{gd}			11.5		
Turn-on delay time	t _{d(on)}	V _{DD} = 380V, V _{GS} = 10V, I _D = 19A, R _G = 1.7Ω		16		nS
Turn-on rise time	t _r			13		
Turn-off delay time	t _{d(off)}			71		
Turn-off fall time	t _f			13		
Source-Drain Diode characteristics						
Diode Forward Current	I _S				38	A
Diode Forward voltage	V _{SD}	V _{GS} = 0V, I _S = 28A, T _J = 25°C		0.9	1.2	V
Reverse Recovery Time	t _{rr}	T _J = 25°C, I _F = 19A di/dt = 100A/μs		180		nS
Reverse Recovery Charge	Q _{rr}			1.6		μC
Peak Reverse Recovery Current	I _{rrm}			18		A

Notes:

- 1) Repetitive Rating: Pulse width limited by maximum junction temperature
- 2) T_J = 25°C, V_{DD} = 50V, V_G = 10V, R_G = 25Ω
- 3) Guaranteed by design, not subject to production

Typical Characteristics

Figure1. Safe operating area

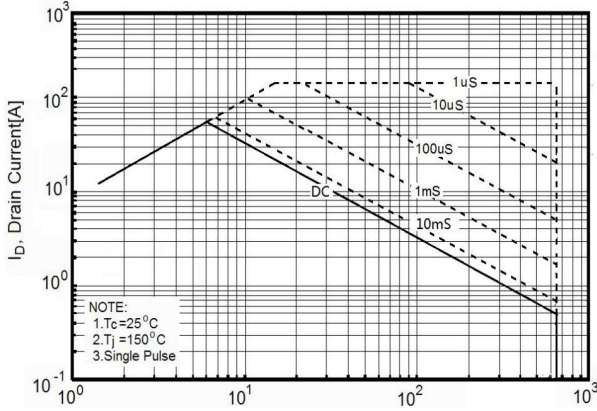

Figure2. Source-Drain Diode Forward Voltage

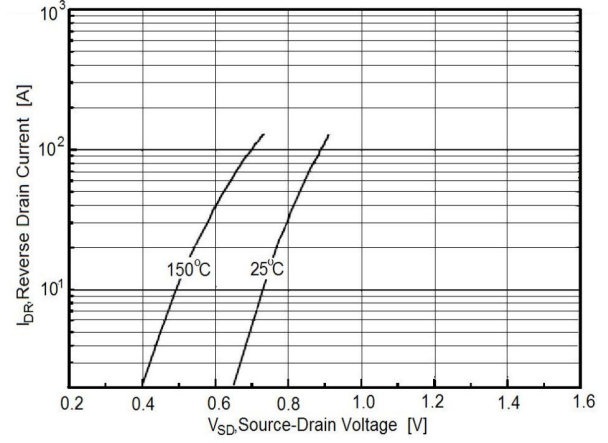

Figure3. Output characteristics

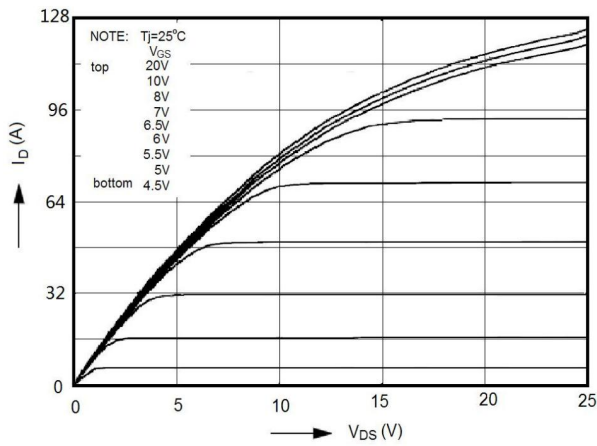

Figure4. Transfer characteristics

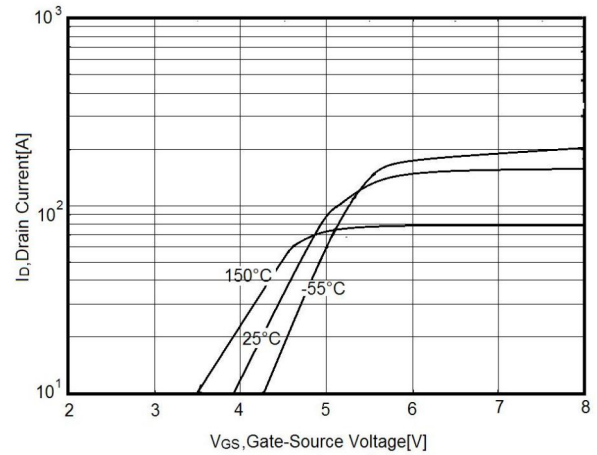

Figure5. Static drain-source on resistance

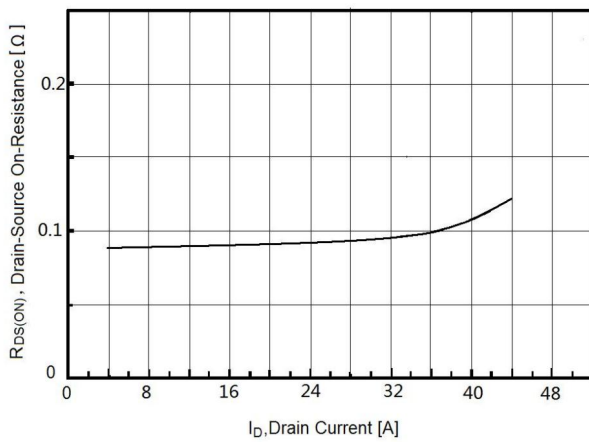
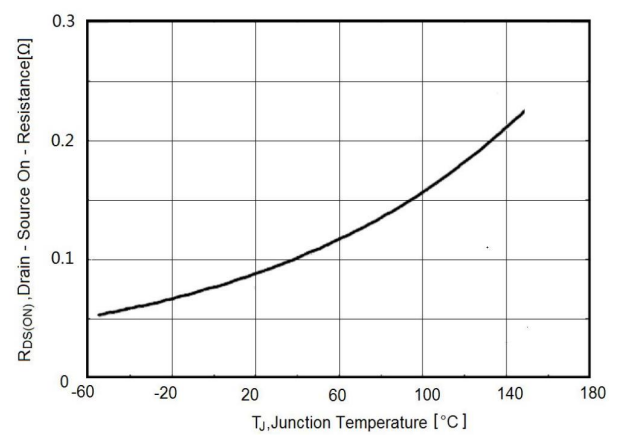

Figure6. RDS(ON) vs Junction Temperature



Typical Characteristics

Figure7. BV_{DSS} vs Junction Temperature

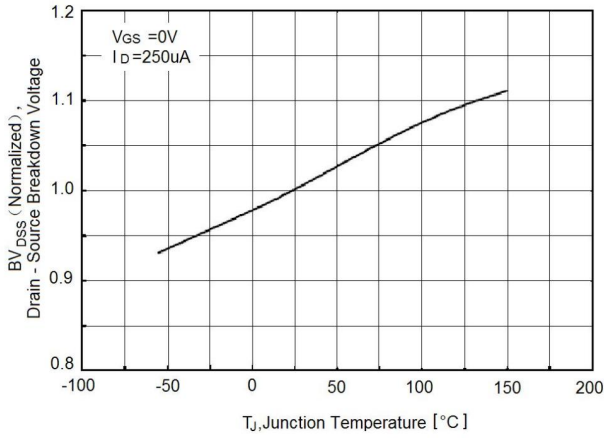

Figure8. Maximum I_D vs Junction Temperature

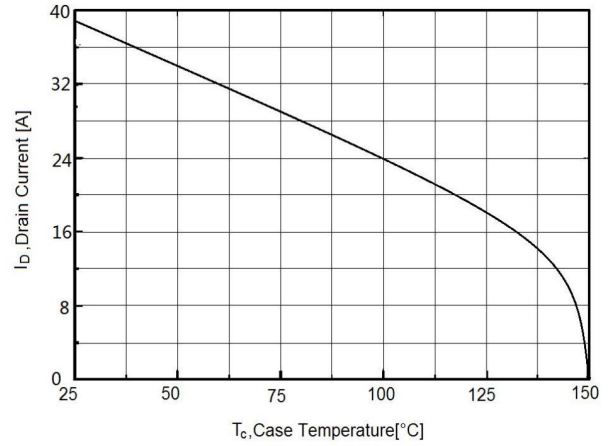

Figure9. Gate charge waveforms

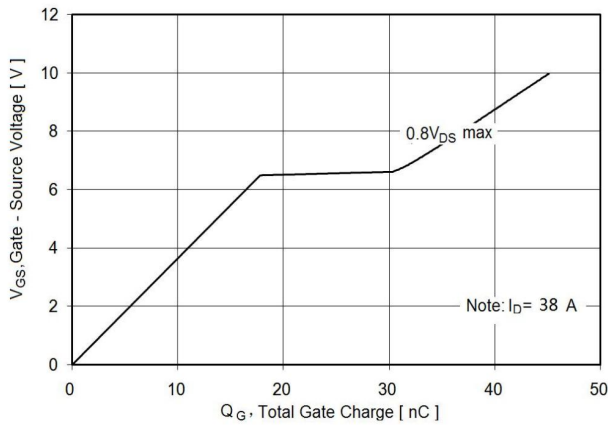
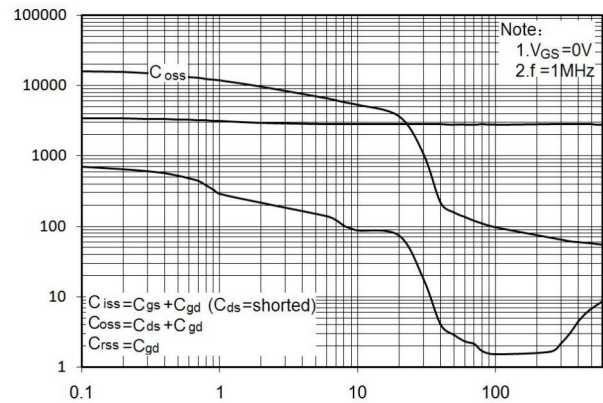
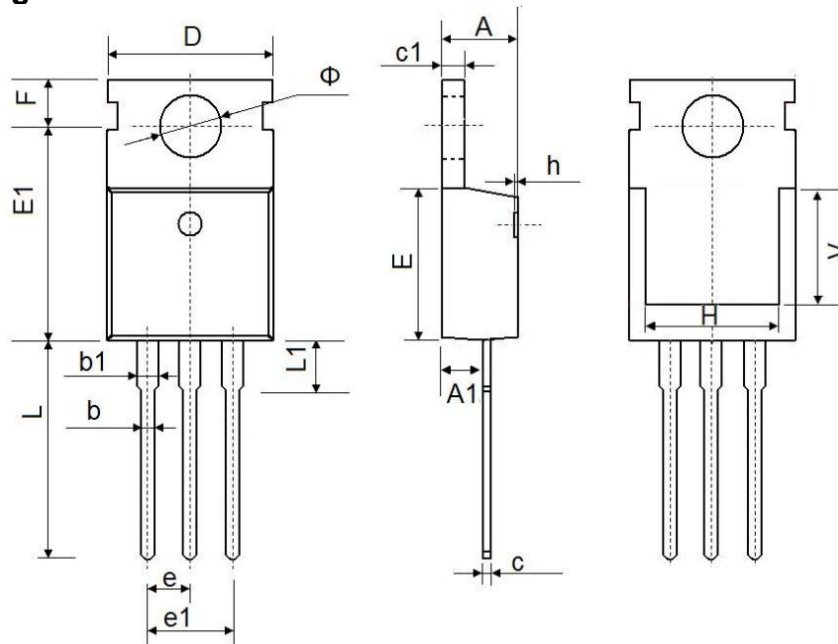

Figure10. Capacitance



TO-220AB Package Information



Symbol	Dimensions In Millimeters		Dimensions In Inches	
	Min.	Max.	Min.	Max.
A	4.400	4.600	0.173	0.181
A1	2.250	2.550	0.089	0.100
b	0.710	0.910	0.028	0.036
b1	1.170	1.370	0.046	0.054
c	0.330	0.650	0.013	0.026
c1	1.200	1.400	0.047	0.055
D	9.910	10.250	0.390	0.404
E	8.950	9.750	0.352	0.384
E1	12.650	12.950	0.498	0.510
e	2.540 TYP		0.100 TYP	
e1	4.980	5.180	0.196	0.204
F	2.650	2.950	0.104	0.116
H	7.900	8.100	0.311	0.319
h	0.000	0.300	0.000	0.012
L	12.900	13.400	0.508	0.528
L1	2.850	3.250	0.112	0.128
V	7.500 REF		0.295 REF	
Φ	3.400	3.800	0.134	0.150