

### Product Summary

$V_{(BR)DSS}$	$R_{DS(on)MAX}$	$I_b$
60V	4.5mΩ@10V	20A
	5.4mΩ@4.5V	

### Feature

- Advanced trench process technology
- High Density Cell Design For Ultra Low On-Resistance

### Application

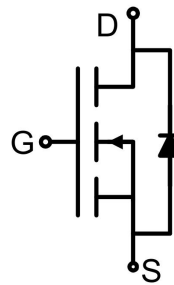
- DC/DC Converter
- Ideal for high-frequency switching and synchronous rectification

### Package

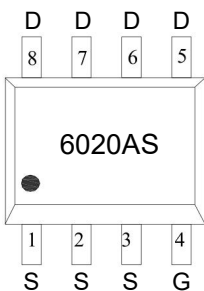


SOP-8

### Circuit diagram



### Marking



### Absolute maximum ratings (Ta=25°C unless otherwise noted)

Parameter	Symbol	Value	Unit
Drain-Source Voltage	V <sub>DS</sub>	60	V
Gate-Source Voltage	V <sub>GS</sub>	±20	V
Continuous Drain Current	I <sub>D</sub>	20	A
Pulsed Drain Current	I <sub>DM</sub>	130	A
Power Dissipation	P <sub>D</sub>	3.5	W
Thermal Resistance from Junction to Ambient	R <sub>θJA</sub>	36	°C/W
Junction Temperature	T <sub>J</sub>	150	°C
Storage Temperature	T <sub>STG</sub>	-55 ~ +150	°C

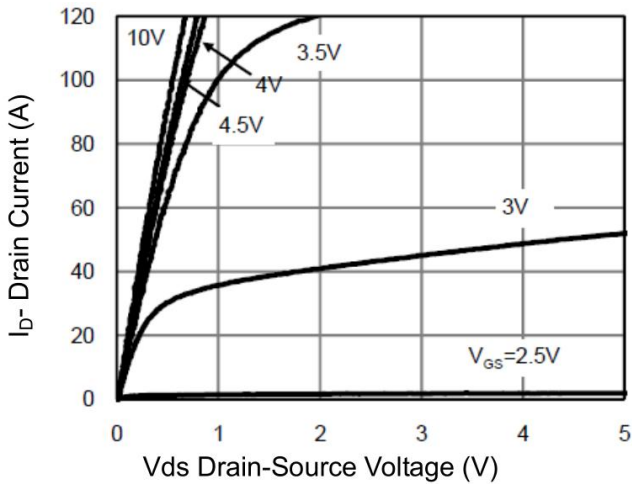
### Electrical characteristics (T<sub>A</sub>=25 °C, unless otherwise noted)

Parameter	Symbol	Test Condition	Min.	Typ.	Max.	Unit
<b>Static Characteristics</b>						
Drain-source breakdown voltage	V <sub>(BR)DSS</sub>	V <sub>GS</sub> = 0V, I <sub>D</sub> = 250μA	60			V
Zero gate voltage drain current	I <sub>DSS</sub>	V <sub>DS</sub> = 60V, V <sub>GS</sub> = 0V			1	μA
Gate-body leakage current	I <sub>GSS</sub>	V <sub>GS</sub> = ±20V, V <sub>DS</sub> = 0V			±100	nA
Gate threshold voltage	V <sub>GS(th)</sub>	V <sub>DS</sub> = V <sub>GS</sub> , I <sub>D</sub> = 250μA	1.0		2.4	V
Drain-source on-resistance <sup>1)</sup>	R <sub>DS(on)</sub>	V <sub>GS</sub> = 10V, I <sub>D</sub> = 20A		4.0	4.5	mΩ
		V <sub>GS</sub> = 4.5V, I <sub>D</sub> = 18A		4.6	5.4	
Forward transconductance <sup>1)</sup>	g <sub>FS</sub>	V <sub>DS</sub> = 5V, I <sub>D</sub> = 20A	35			S
<b>Dynamic characteristics<sup>2)</sup></b>						
Input Capacitance	C <sub>iss</sub>	V <sub>DS</sub> = 30V, V <sub>GS</sub> = 0V, f = 1MHz		4000		pF
Output Capacitance	C <sub>oss</sub>			680		
Reverse Transfer Capacitance	C <sub>rss</sub>			23		
Total Gate Charge	Q <sub>g</sub>	V <sub>DS</sub> = 30V, V <sub>GS</sub> = 10V, I <sub>D</sub> = 20A		67		nC
Gate-Source Charge	Q <sub>gs</sub>			12		
Gate-Drain Charge	Q <sub>gd</sub>			8.5		
Turn-on delay time	t <sub>d(on)</sub>	V <sub>DD</sub> = 30V, V <sub>GS</sub> = 10V, R <sub>L</sub> = 1.7Ω, R <sub>GEN</sub> = 3Ω		11		nS
Turn-on rise time	t <sub>r</sub>			5		
Turn-off delay time	t <sub>d(off)</sub>			56		
Turn-off fall time	t <sub>f</sub>			12		
<b>Source-Drain Diode characteristics</b>						
Diode Forward Current <sup>1)</sup>	I <sub>S</sub>				20	A
Diode Forward voltage	V <sub>DS</sub>	V <sub>GS</sub> = 0V, I <sub>S</sub> = 20A			1.2	V

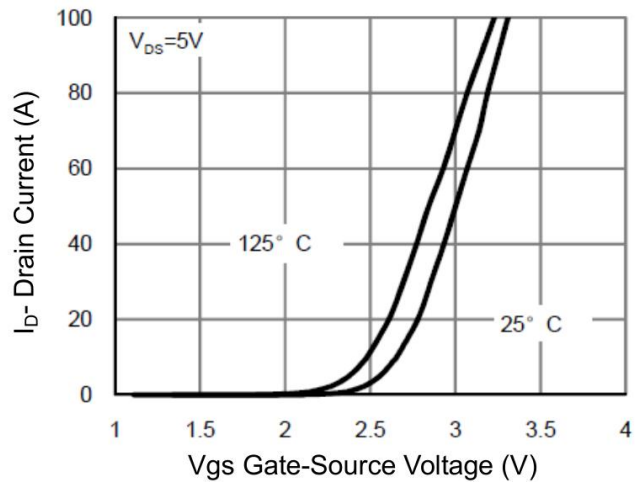
Notes:

- 1) Pulse Test: Pulse Width < 300μs, Duty Cycle ≤ 2%.
- 2) Guaranteed by design, not subject to production testing.

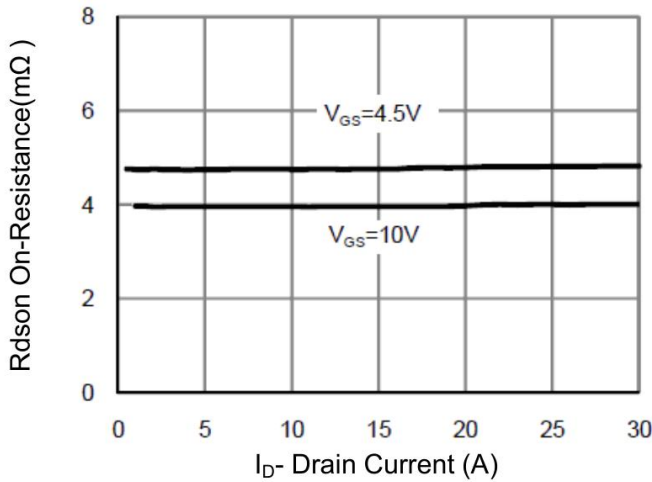
## Typical Characteristics



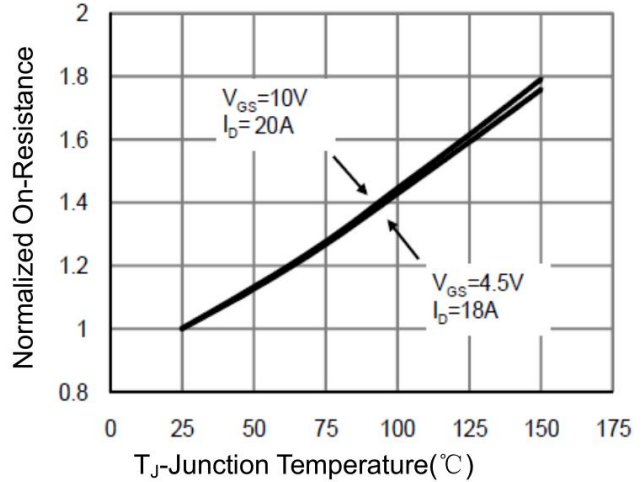
**Figure 1 Output Characteristics**



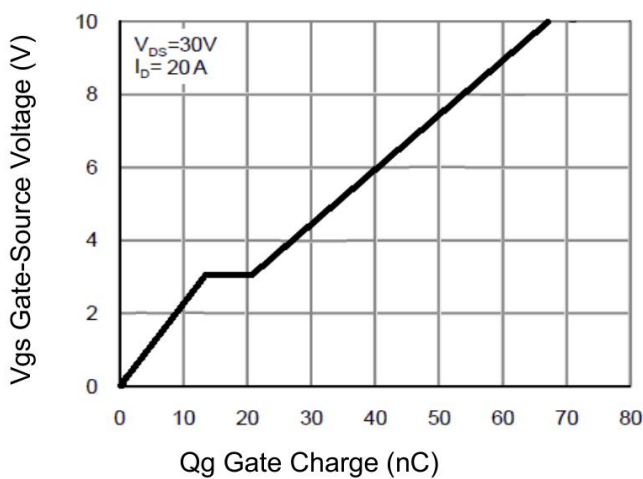
**Figure 2 Transfer Characteristics**



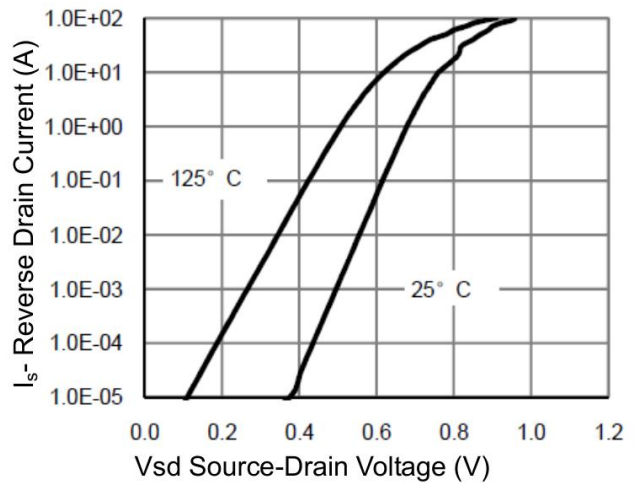
**Figure 3 Rdson- Drain Current**



**Figure 4 Rdson-Junction Temperature**

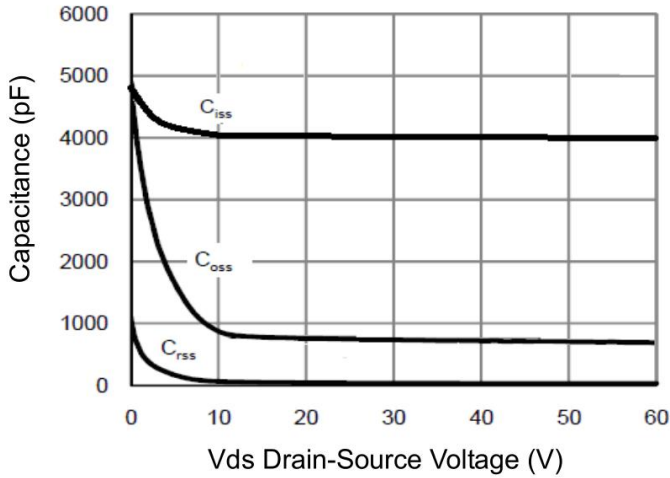


**Figure 5 Gate Charge**

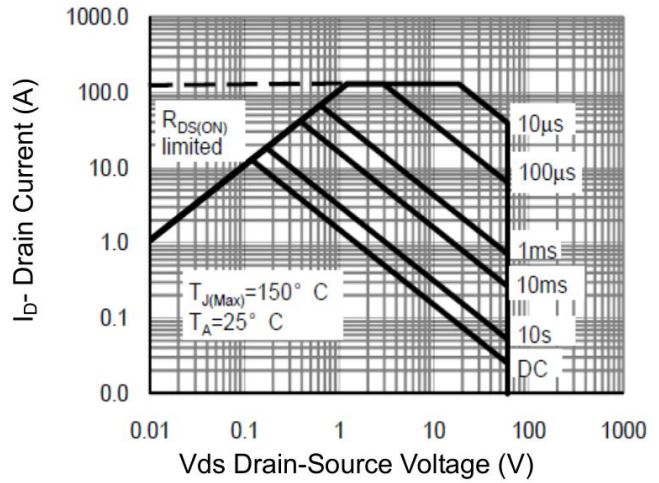


**Figure 6 Source- Drain Diode Forward**

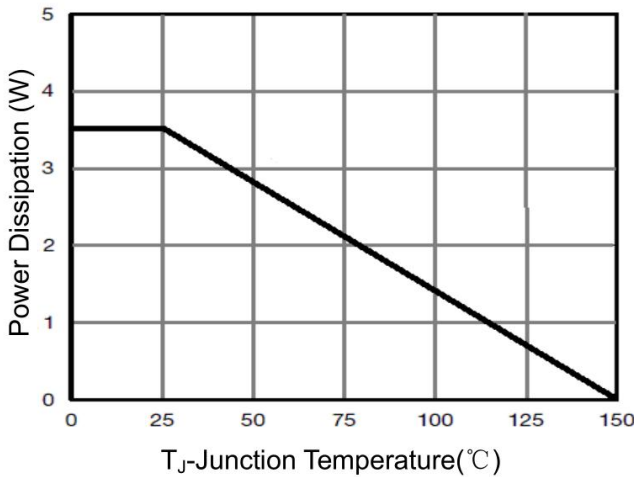
## Typical Characteristics



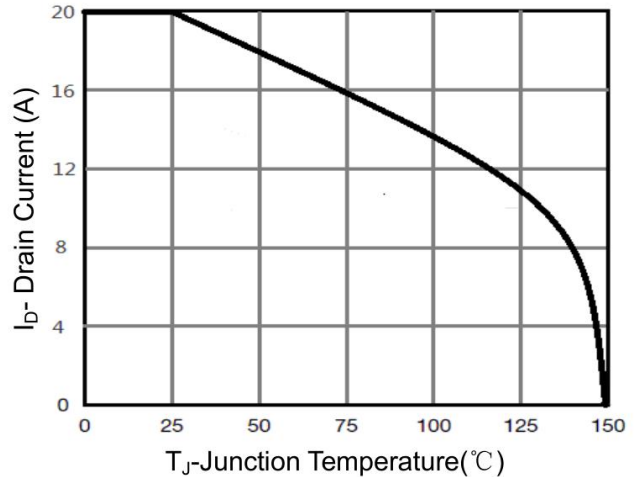
**Figure 7 Capacitance vs Vds**



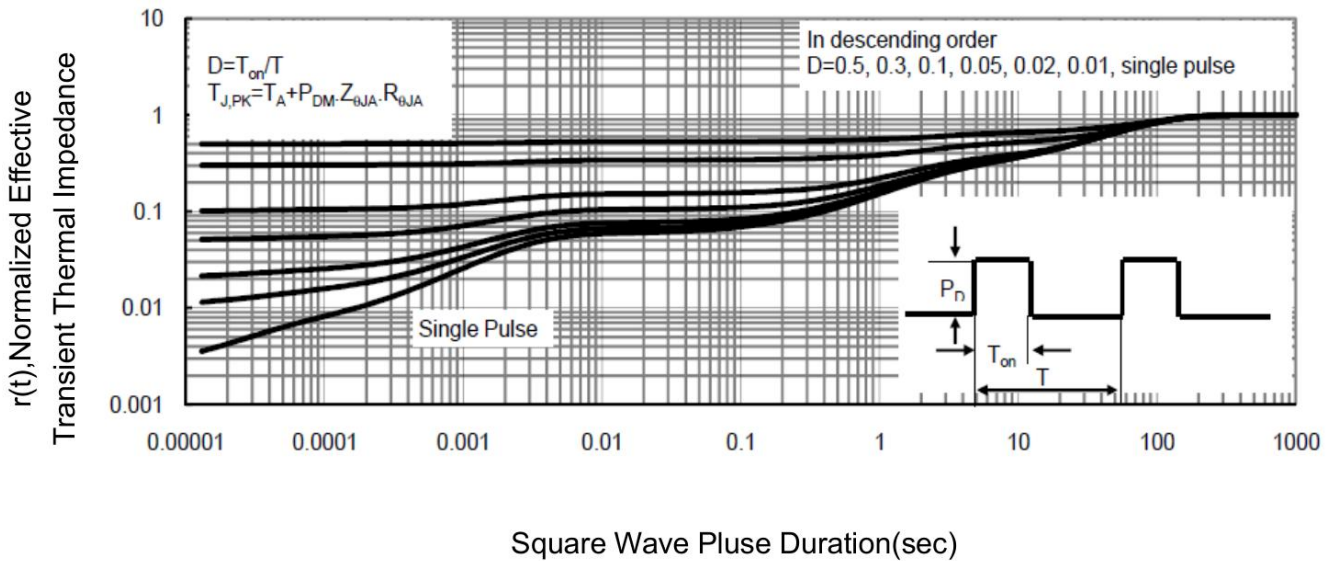
**Figure 8 Safe Operation Area**



**Figure 9 Power De-rating**

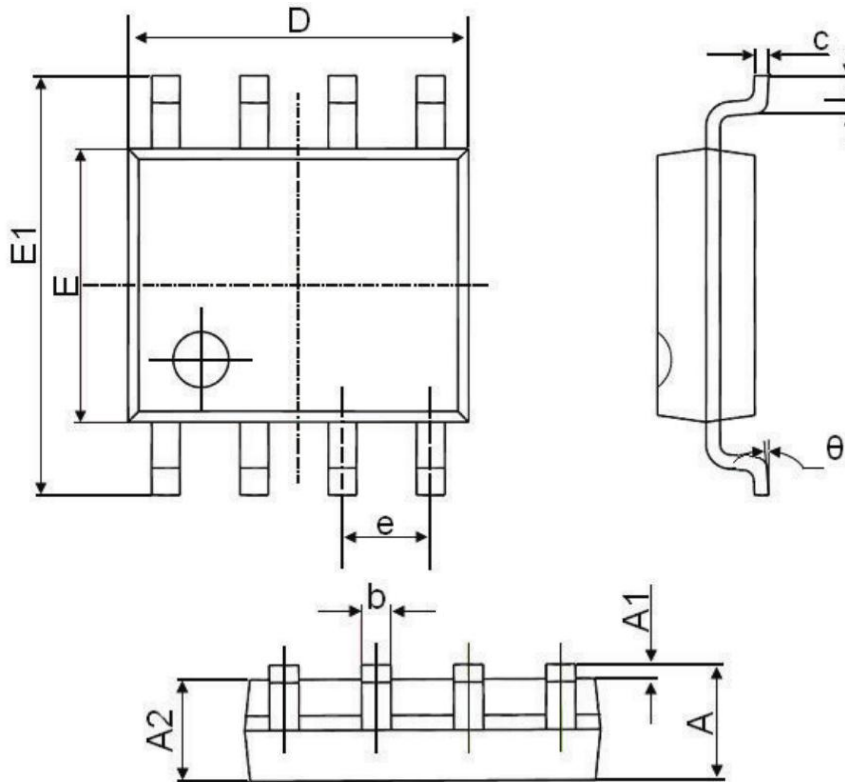


**Figure 10 Current De-rating**



**Figure 11 Normalized Maximum Transient Thermal Impedance**

## SOP-8 Package Information



Symbol	Dimensions In Millimeters		Dimensions In Inches	
	Min.	Max.	Min.	Max.
A	1.350	1.750	0.053	0.069
A1	0.100	0.250	0.004	0.010
A2	1.350	1.550	0.053	0.061
b	0.330	0.510	0.013	0.020
c	0.170	0.250	0.006	0.010
D	4.700	5.100	0.185	0.200
E	3.800	4.000	0.150	0.157
E1	5.800	6.200	0.228	0.244
e	1.270(BSC)		0.050(BSC)	
L	0.400	1.270	0.016	0.050
θ	0°	8°	0°	8°