

Product Summary

$V_{(BR)DSS}$	$R_{DS(on)MAX}$	I_D	$V_{(BR)DSS}$	$R_{DS(on)MAX}$	I_D
30V	18mΩ@10V	7A	-30V	43mΩ@-10V	-5A
	30mΩ@4.5V			63mΩ@-4.5V	

Feature

- Trench Power LV MOSFET technology
- High density cell design for low $R_{DS(on)}$
- High Speed switching

Application

- Wireless charger
- Load switch
- Power management

Package



SOP-8

Circuit diagram

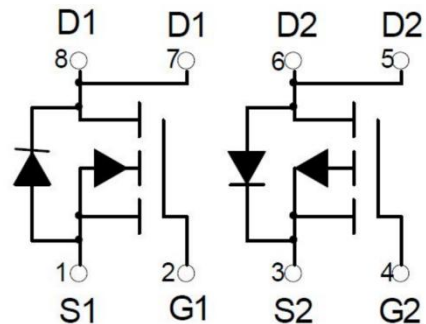

Marking



Absolute maximum ratings (T_A=25°C unless otherwise noted)

Parameter	Symbol	N-Channel	p-Channel	Unit
Drain-Source Voltage	V _{DS}	30	-30	V
Gate-Source Voltage	V _{GS}	±20	±20	V
Continuous Drain Current	I _D	7	-5	A
Continuous Drain Current(T _A =100°C)	I _D (100°C)	4.4	-3	A
Pulsed Drain Current ¹⁾	I _{DM}	60	-40	A
Power Dissipation ²⁾	P _D	2	2	W
Thermal Resistance,Junction-to-Ambient ³⁾	R _{θJA}	60	60	°C/W
Junction Temperature	T _J	150	150	°C
Storage Temperature	T _{STG}	-55 ~ +150	-55 ~ +150	°C

N-CH Electrical characteristics (T_J=25°C unless otherwise noted)

Parameter	Symbol	Test Condition	Min	Typ	Max	Unit
Static Characteristics						
Drain-source breakdown voltage	V _{(BR)DSS}	V _{GS} = 0V, I _D = 250μA	30			V
Zero gate voltage drain current	I _{DSS}	V _{DS} = 30V, V _{GS} = 0V			1	μA
Gate-body leakage current	I _{GSS}	V _{GS} = ±20V, V _{DS} = 0V			±100	nA
Gate threshold voltage	V _{GS(th)}	V _{DS} = V _{GS} , I _D = 250μA	1.0	1.5	2.2	V
Drain-source on-resistance	R _{DS(on)}	V _{GS} = 10V, I _D = 7A		15	18	mΩ
		V _{GS} = 4.5V, I _D = 5A		23	30	mΩ
Dynamic characteristics⁴⁾						
Input Capacitance	C _{iss}	V _{DS} = 15V, V _{GS} = 0V, f = 1MHz		380		pF
Output Capacitance	C _{oss}			75		
Reverse Transfer Capacitance	C _{rss}			60		
Total Gate Charge	Q _g	V _{DS} = 15V, V _{GS} = 10V, I _D = 7A		12.5		nC
Gate-Source Charge	Q _{gs}			2.5		
Gate-Drain Charge	Q _{gd}			2.5		
Turn-on delay time	t _{d(on)}	V _{DD} = 15V, V _{GS} = 10V R _{GEN} = 3Ω, I _D = 7A		5		nS
Turn-on rise time	t _r			30		
Turn-off delay time	t _{d(off)}			15		
Turn-off fall time	t _f			20		
Source-Drain Diode characteristics						
Diode Forward Current	I _S				7	A
Diode Forward voltage	V _{SD}	V _{GS} = 0V, I _S = 7A			1.2	V
Reverse Recovery Time	t _{rr}	I _F = 7A, di/dt = 100A/us		16		nS
Reverse Recovery Charge	Q _{rr}				1.5	

P-CH Electrical characteristics (T_J=25°C unless otherwise noted)

Parameter	Symbol	Test Condition	Min	Typ	Max	Unit
Static Characteristics						
Drain-source breakdown voltage	V _{(BR)DSS}	V _{GS} =0V, I _D =-250μA	-30			V
Zero gate voltage drain current	I _{DSS}	V _{DS} =-30V, V _{GS} =0V			-1	μA
Gate-body leakage current	I _{GSS}	V _{GS} =±20V, V _{DS} =0V			±100	nA
Gate threshold voltage	V _{GS(th)}	V _{DS} =V _{GS} , I _D =-250μA	-1.0	-1.5	-2.4	V
Drain-source on-resistance	R _{DS(on)}	V _{GS} =-10V, I _D =-5A		34	43	mΩ
		V _{GS} =-4.5V, I _D =-3.5A		49	63	mΩ
Dynamic characteristics⁴⁾						
Input Capacitance	C _{iss}	V _{DS} =-15V, V _{GS} =0V, f =1MHz		490		pF
Output Capacitance	C _{oss}			75		
Reverse Transfer Capacitance	C _{rss}			60		
Total Gate Charge	Q _g	V _{DS} =-15V, V _{GS} =-10V, I _D =-5A		9		nC
Gate-Source Charge	Q _{gs}			1.5		
Gate-Drain Charge	Q _{gd}			2.3		
Turn-on delay time	t _{d(on)}	V _{DD} =-15V, V _{GS} =-10V, I _D =-5A, R _{GEN} =2.5Ω		9		nS
Turn-on rise time	t _r			3		
Turn-off delay time	t _{d(off)}			29		
Turn-off fall time	t _f			15		
Source-Drain Diode characteristics						
Diode Forward Current	I _S				-5	A
Diode Forward voltage	V _{SD}	V _{GS} =0V, I _S =-5A			-1.2	V
Reverse Recovery Time	t _{rr}	I _F =-5A, di/dt =100A/us		32		nS
Reverse Recovery Charge	Q _{rr}			12		nC

Notes:

- 1) Repetitive rating; pulse width limited by max. junction temperature.
- 2) P_d is based on max. junction temperature, using junction-case thermal resistance.
- 3) The value of R_{θJA} is measured with the device mounted on 1 in² FR-4 board with 2oz. Copper, in the still air environment with T_A=25°C. The maximum allowed junction temperature of 150°C. The value in any given application depends on the user's specific board design.
- 4) Guaranteed by design, not subject to production.

N- Channel Typical Characteristics

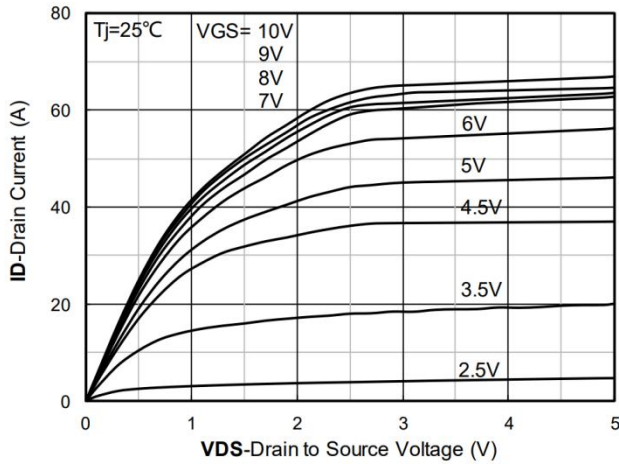

Figure 1. Output Characteristics

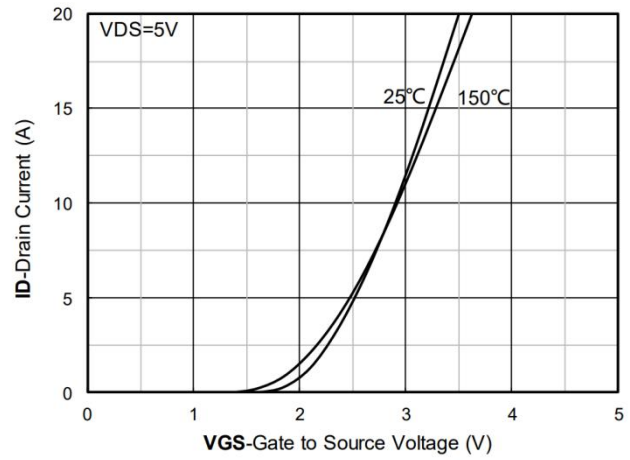

Figure 2. Transfer Characteristics

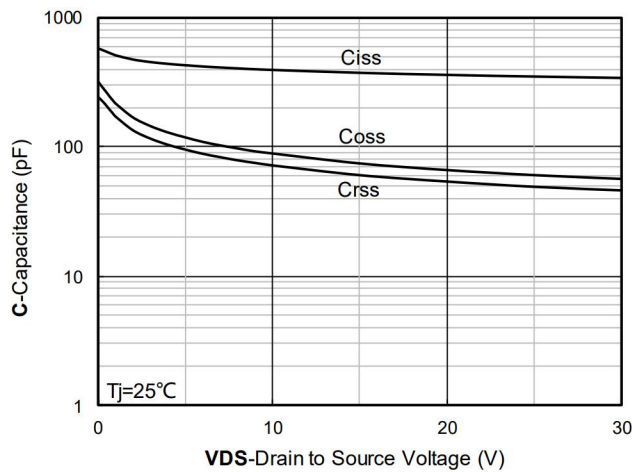

Figure 3. Capacitance Characteristics

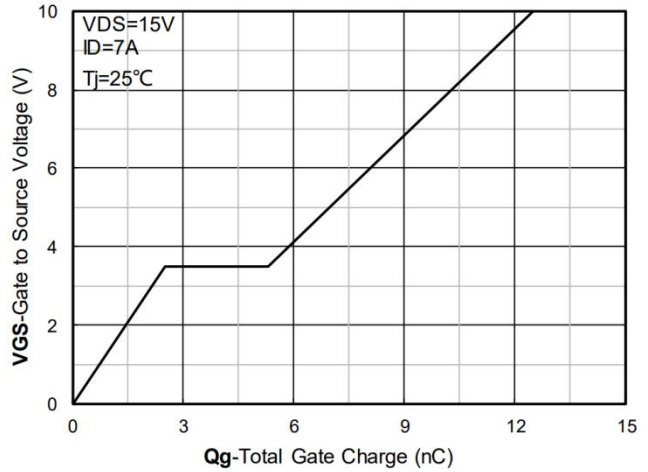

Figure 4. Gate Charge

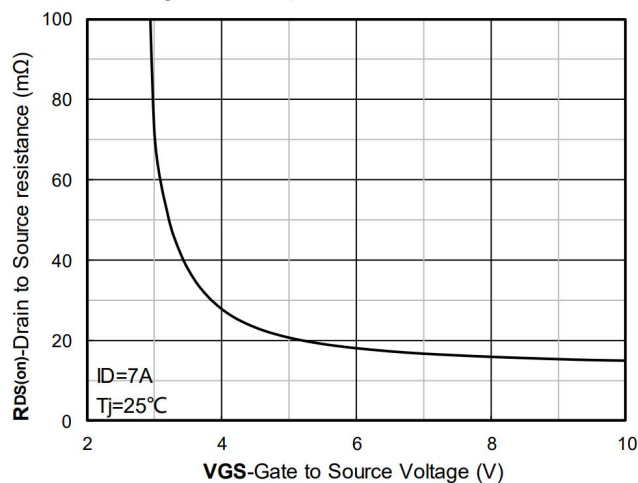

Figure 5. On-Resistance vs Gate to Source Voltage

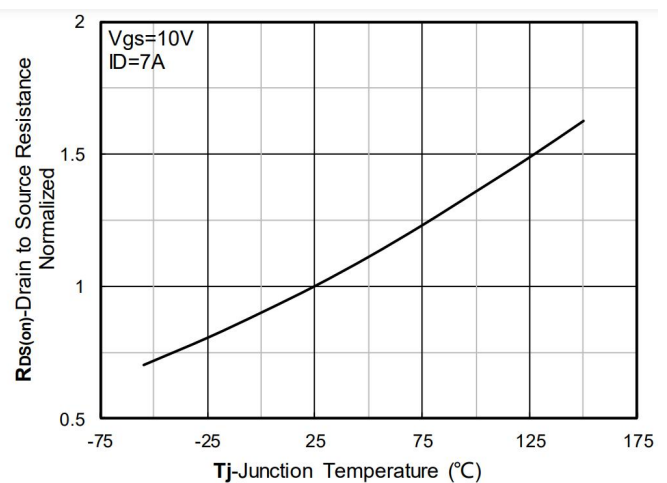

Figure 6. Normalized On- Resistance

N- Channel Typical Characteristics

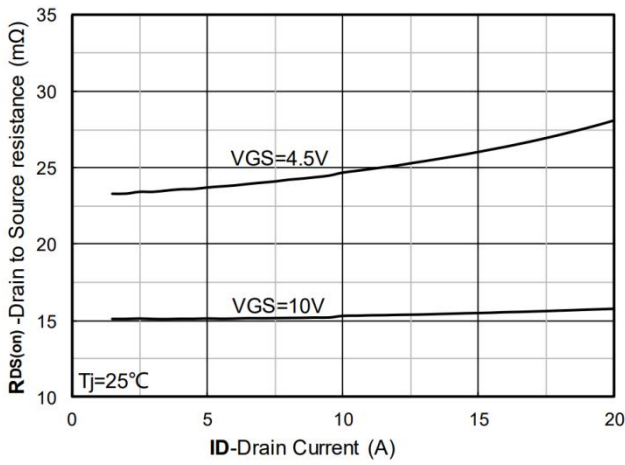

Figure 7. $R_{DS(on)}$ VS Drain Current

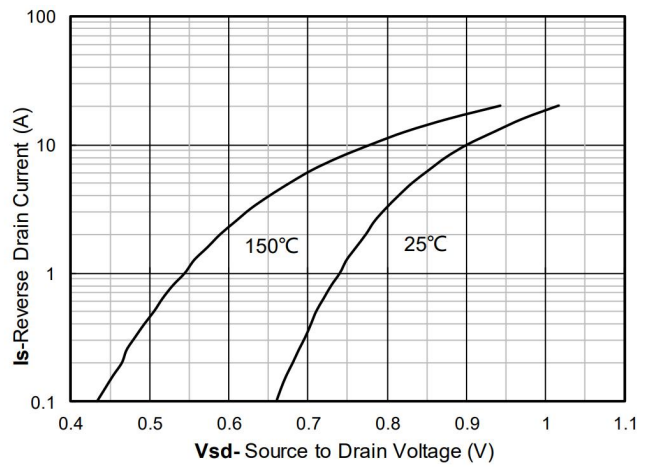

Figure 8. Forward characteristics of reverse diode

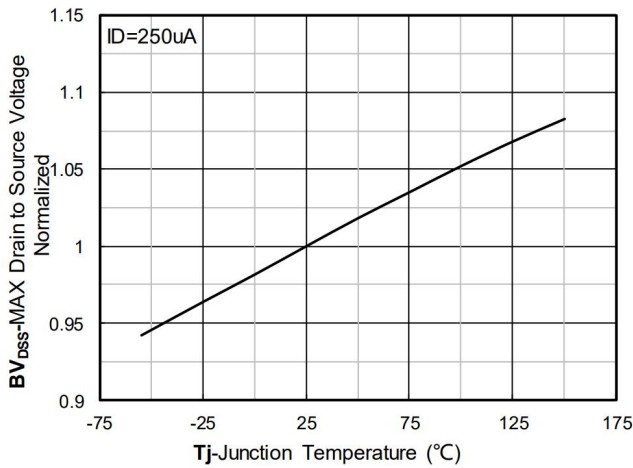

Figure 9. Normalized breakdown voltage

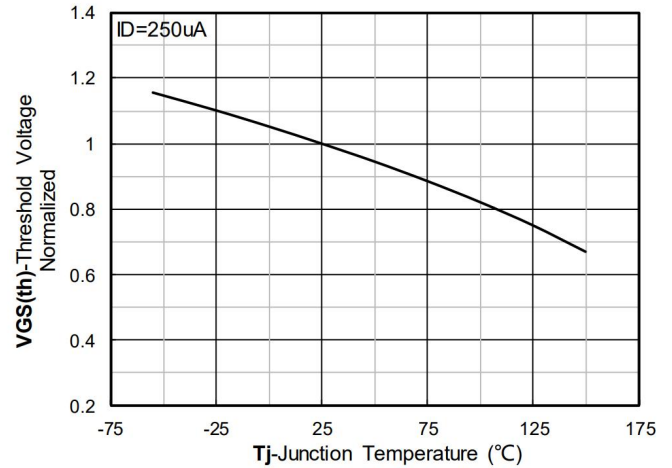

Figure 10. Normalized Threshold voltage

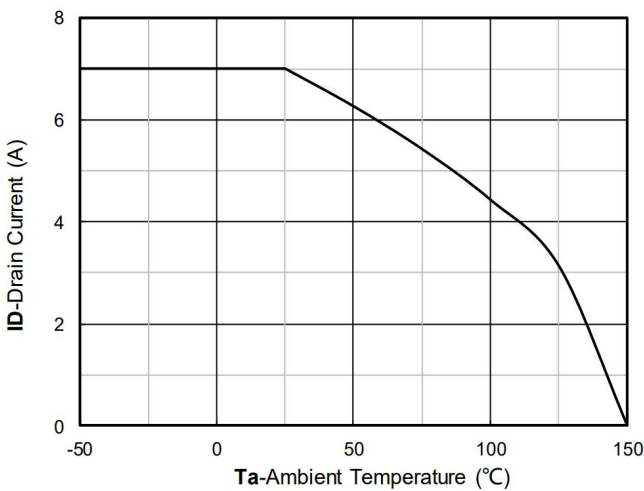

Figure 11. Current dissipation

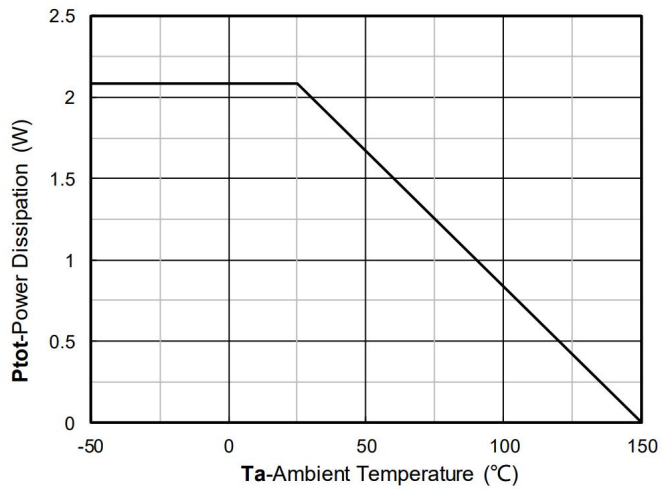

Figure 12. Power dissipation

N- Channel Typical Characteristics

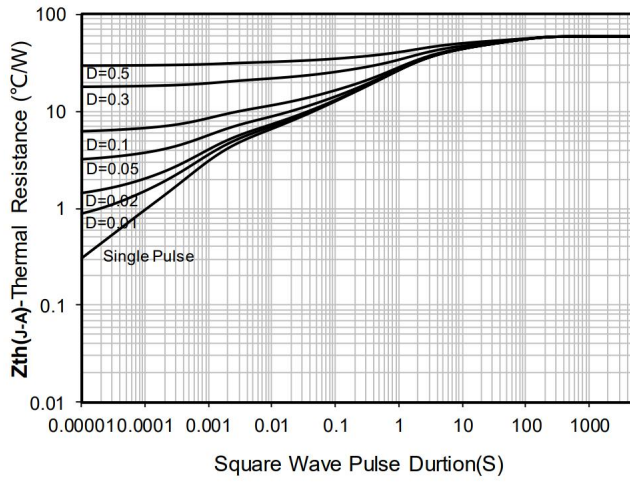

Figure 13. Maximum Transient Thermal Impedance

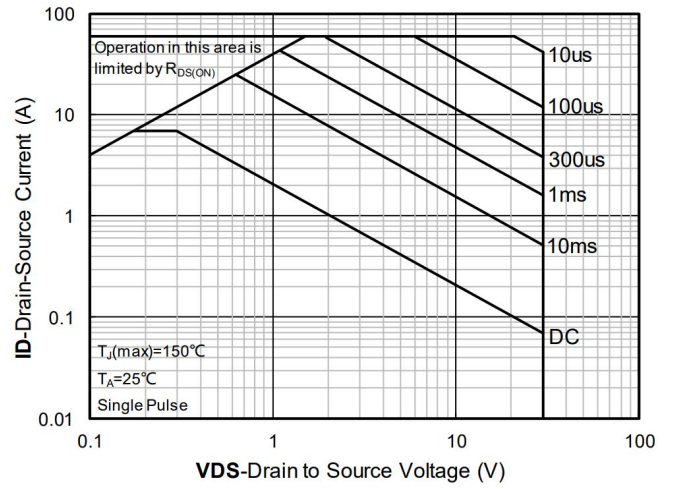

Figure 14. Safe Operation Area

P- Channel Typical Characteristics

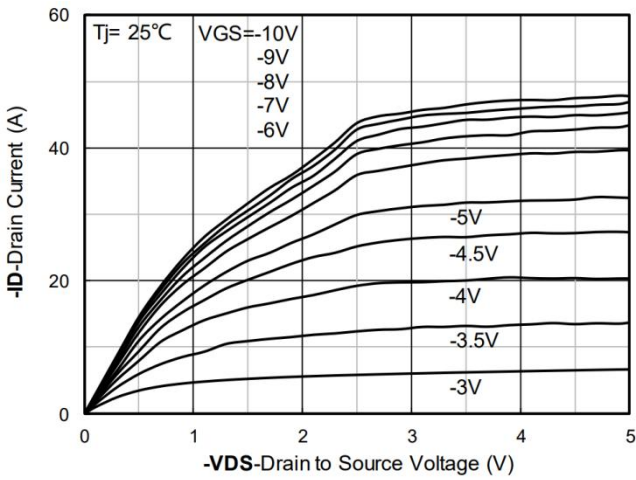

Figure 1. Output Characteristics

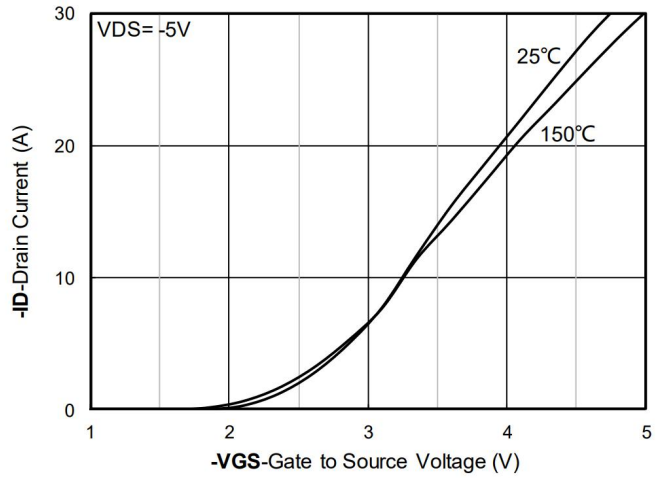

Figure 2. Transfer Characteristics

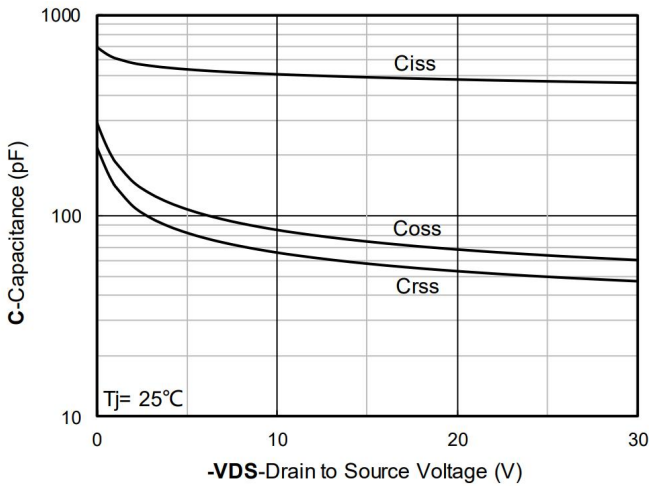

Figure 3. Capacitance Characteristics

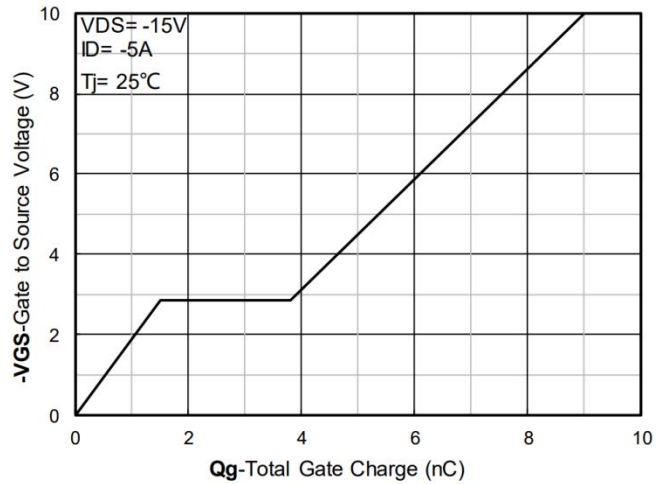

Figure 4. Gate Charge

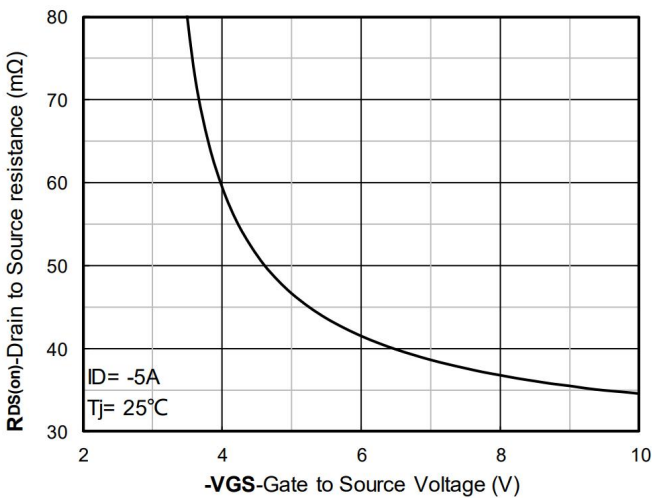

Figure 5. On-Resistance vs Gate to Source Voltage

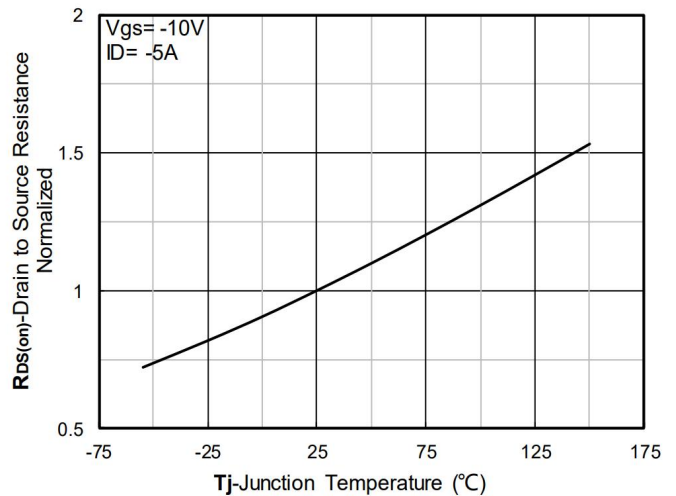

Figure 6. Normalized On-Resistance

P- Channel Typical Characteristics

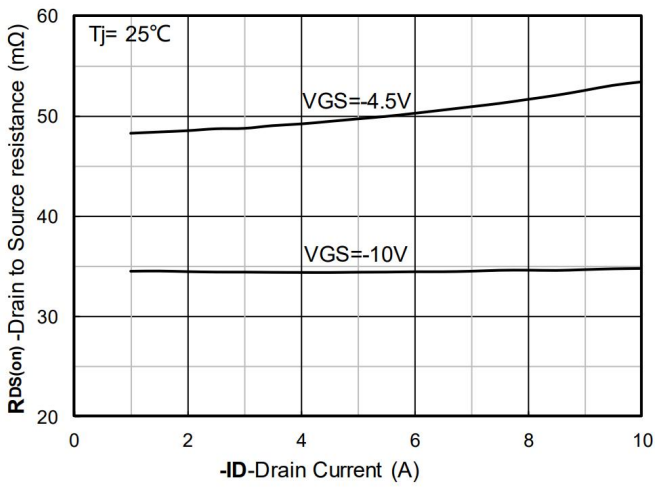

Figure 7. RDS(on) VS Drain Current

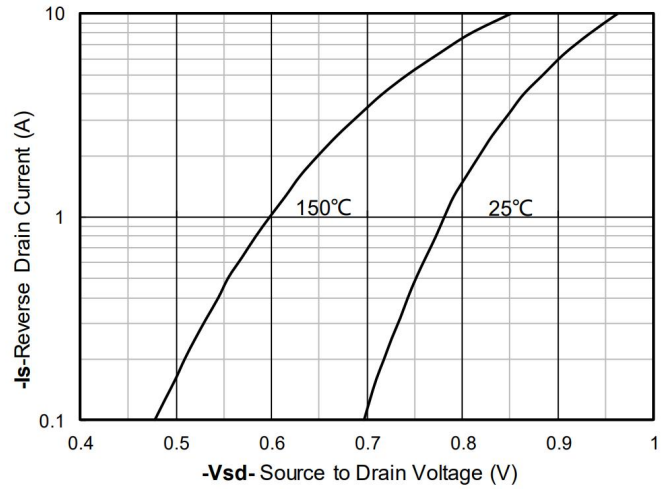

Figure 8. Forward characteristics of reverse diode

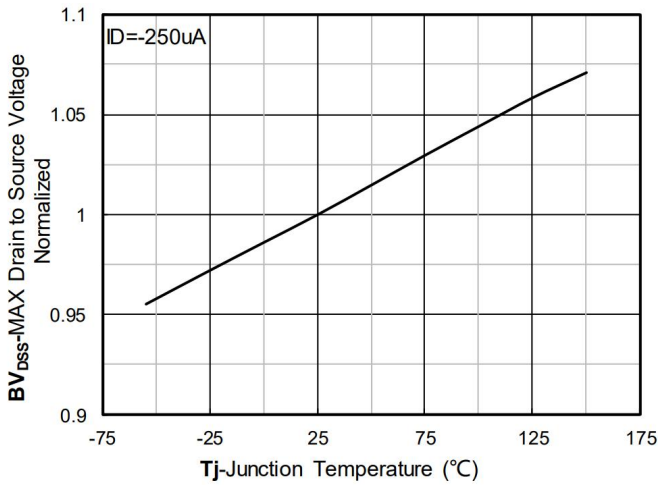

Figure 9. Normalized breakdown voltage

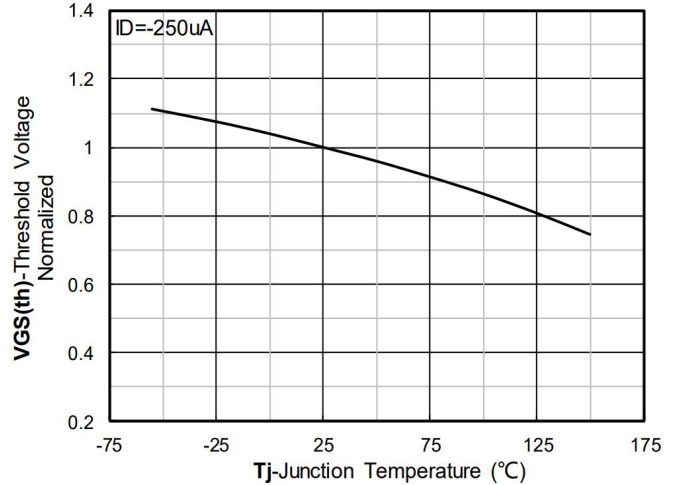

Figure 10. Normalized Threshold voltage

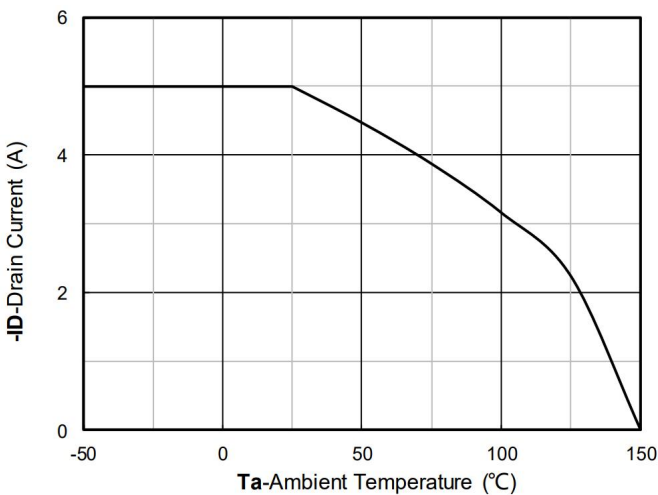

Figure 11. Current dissipation

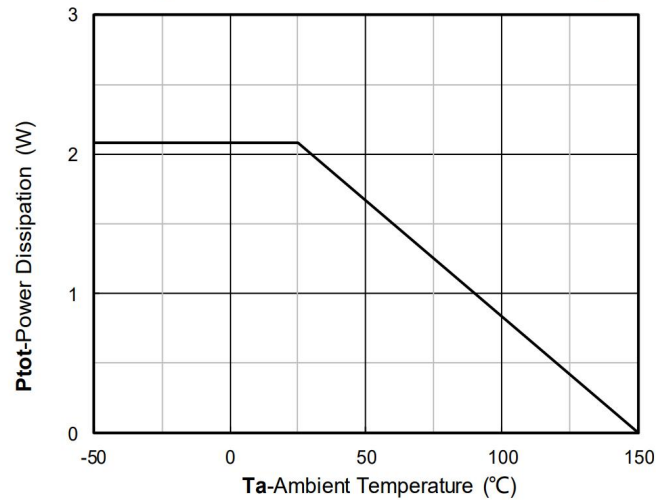

Figure 12. Power dissipation

P- Channel Typical Characteristics

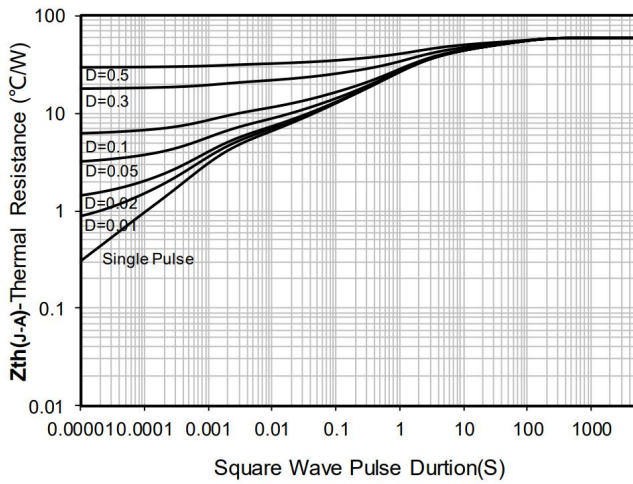

Figure 13. Maximum Transient Thermal Impedance

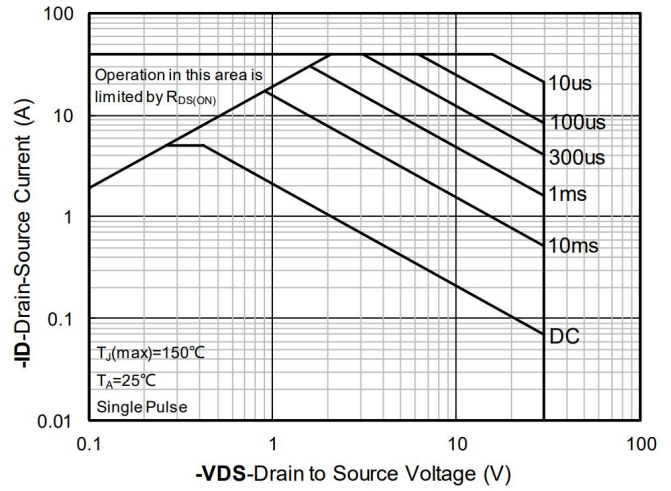
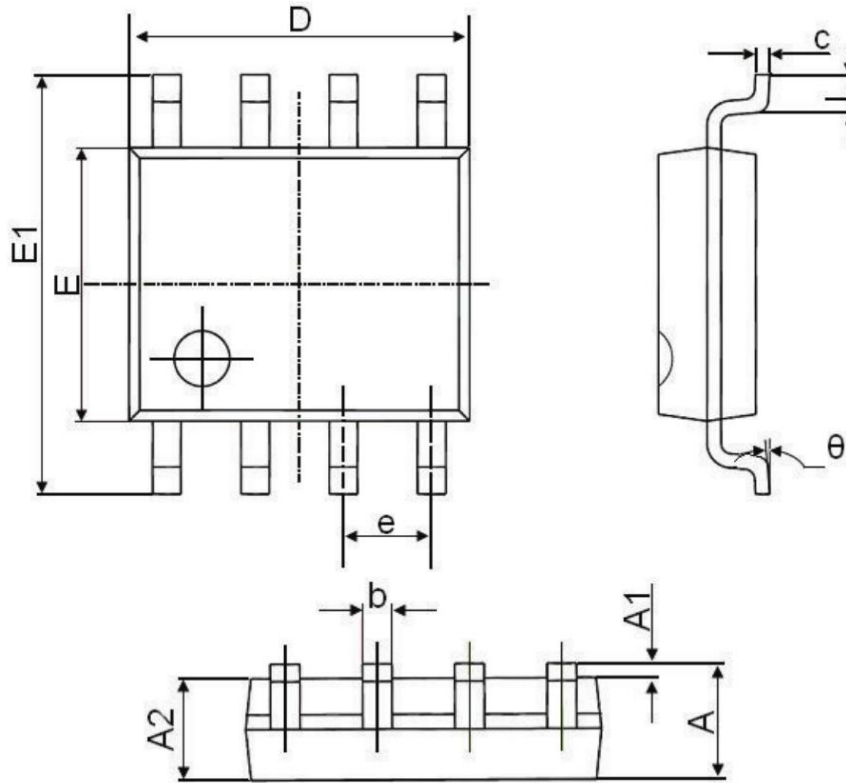

Figure 14. Safe Operation Area

SOP-8 Package Information



Symbol	Dimensions In Millimeters		Dimensions In Inches	
	Min.	Max.	Min.	Max.
A	1.350	1.750	0.053	0.069
A1	0.100	0.250	0.004	0.010
A2	1.250	1.650	0.049	0.065
b	0.330	0.510	0.013	0.020
c	0.170	0.250	0.007	0.010
D	4.700	5.100	0.185	0.200
E	3.800	4.000	0.150	0.157
E1	5.800	6.200	0.228	0.244
e	1.270(BSC)		0.050(BSC)	
L	0.400	1.270	0.016	0.050
θ	0°	8°	0°	8°