

Product Summary

$V_{(BR)DSS}$	$R_{DS(on)MAX}$	I_b
-30V	12mΩ@-10V	-15A

Feature

- Advanced trench process technology
- High Density Cell Design For Ultra Low On-Resistance
- Suffix "-Q1" for AEC-Q101

Application

- PWM applications
- Load switch
- Uninterruptible power supply

Package



SOP-8

Circuit diagram

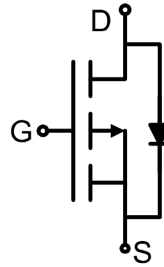

Marking



Absolute maximum ratings ($T_A=25^\circ\text{C}$, unless otherwise noted)

Parameter	Symbol	Value	Unit
Drain-Source Voltage	V_{DS}	-30	V
Gate-Source Voltage	V_{GS}	± 20	V
Continuous Drain Current	I_D	-15	A
Pulsed Drain Current	I_{DM}	-80	A
Power Dissipation	P_D	3.1	W
Thermal Resistance from Junction to Ambient	$R_{\theta JA}$	40	$^\circ\text{C/W}$
Junction Temperature	T_J	150	$^\circ\text{C}$
Storage Temperature	T_{STG}	-55 ~ +150	$^\circ\text{C}$

Electrical characteristics ($T_A=25^\circ\text{C}$, unless otherwise noted)

Parameter	Symbol	Test Condition	Min.	Typ.	Max.	Unit
Static Characteristics						
Drain-source breakdown voltage	$V_{(BR)DSS}$	$V_{GS} = 0V, I_D = -250\mu\text{A}$	-30			V
Zero gate voltage drain current	I_{DSS}	$V_{DS} = -30V, V_{GS} = 0V$			-1	μA
Gate-body leakage current	I_{GSS}	$V_{GS} = \pm 20V, V_{DS} = 0V$			± 100	nA
Gate threshold voltage	$V_{GS(th)}$	$V_{DS} = V_{GS}, I_D = -250\mu\text{A}$	-1.0		-2.2	V
Drain-source on-resistance ¹⁾	$R_{DS(on)}$	$V_{GS} = -10V, I_D = -15A$		8.5	12	m Ω
Forward transconductance ¹⁾	g_{FS}	$V_{DS} = -5V, I_D = -15A$	30			S
Dynamic characteristics²⁾						
Input Capacitance	C_{iss}	$V_{DS} = -15V, V_{GS} = 0V, f = 1\text{MHz}$		2900		pF
Output Capacitance	C_{oss}			410		
Reverse Transfer Capacitance	C_{rss}			280		
Total Gate Charge	Q_g	$V_{DS} = -15V, V_{GS} = -10V, I_D = -10A$		48		nC
Gate-Source Charge	Q_{gs}			12		
Gate-Drain Charge	Q_{gd}			14		
Turn-on delay time	$t_{d(on)}$	$V_{DD} = -15V, V_{GS} = -10V, I_D = -10A, R_{GEN} = 3\Omega$		15		nS
Turn-on rise time	t_r			11		
Turn-off delay time	$t_{d(off)}$			44		
Turn-off fall time	t_f			21		
Source-Drain Diode characteristics						
Diode Forward voltage	V_{DS}	$V_{GS} = 0V, I_S = -2A$			-1.2	V

Notes:

- 1) Pulse Test: Pulse Width < 300 μs , Duty Cycle $\leq 2\%$.
- 2) Guaranteed by design, not subject to production testing.

Typical Characteristics

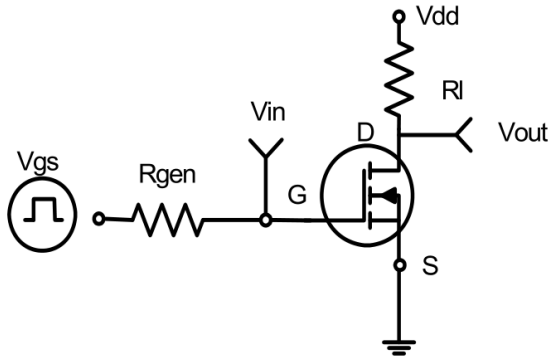

Figure 1: Switching Test Circuit

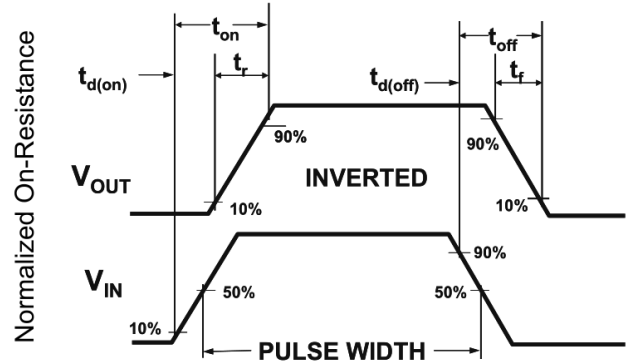

Figure 2: Switching Waveforms

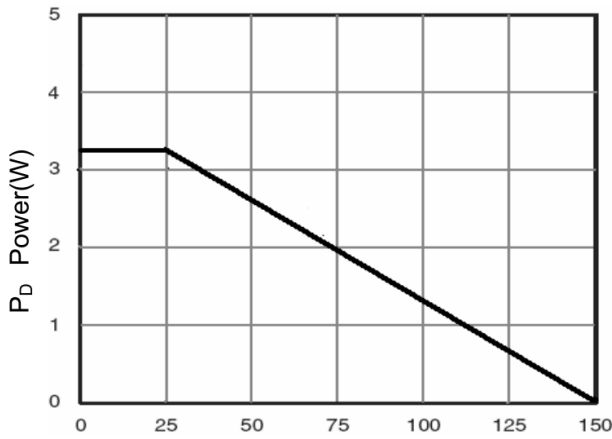

Figure 3 Power Dissipation

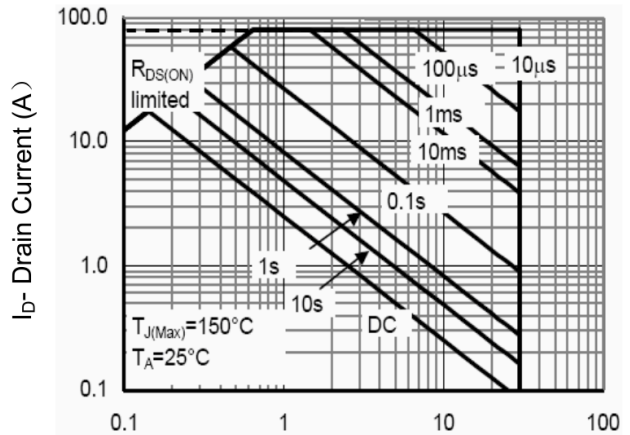

Figure 4 Safe Operation Area

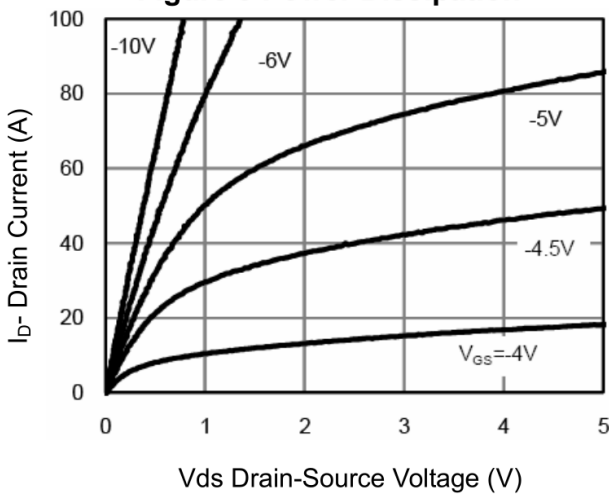

Figure 5 Output Characteristics

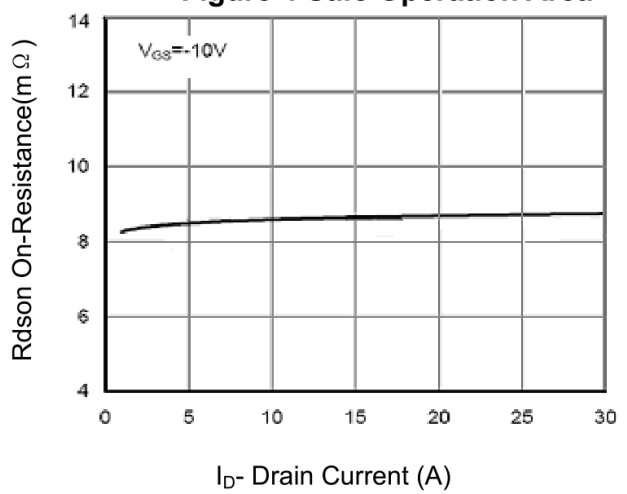

Figure 6 Drain-Source On-Resistance

Typical Characteristics

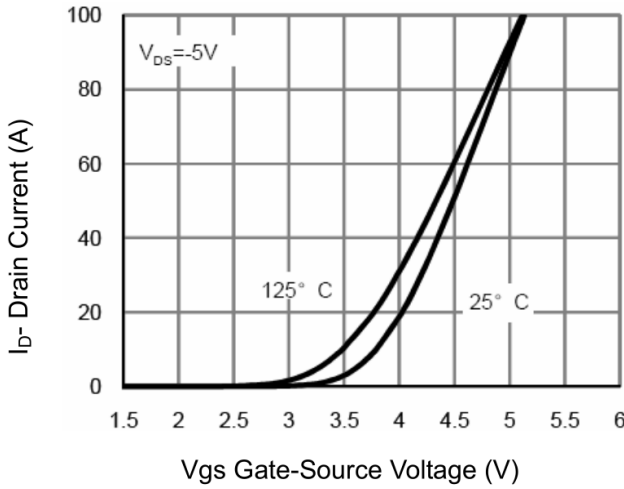

Figure 7 Transfer Characteristics

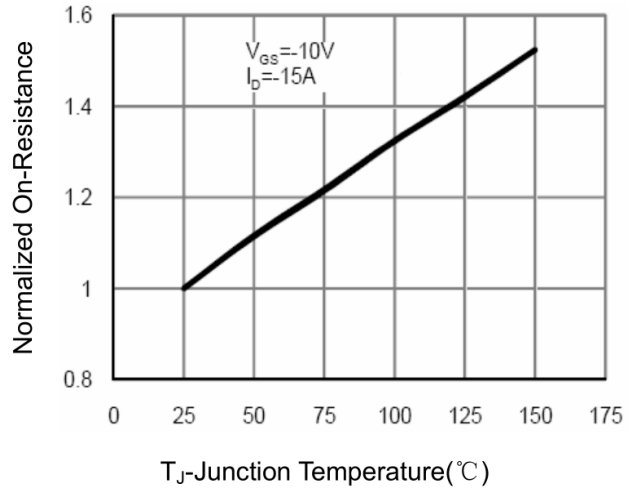

Figure 8 Drain-Source On-Resistance

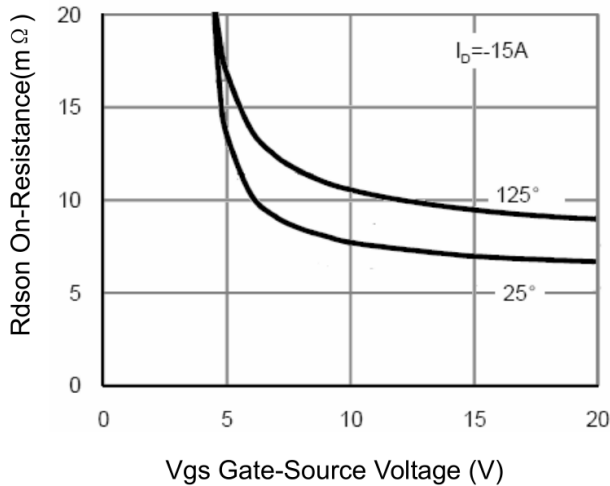

Figure 9 Rdson vs Vgs

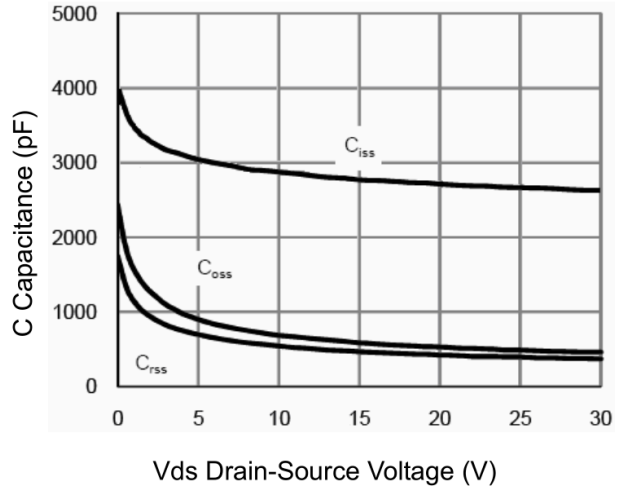

Figure 10 Capacitance vs Vds

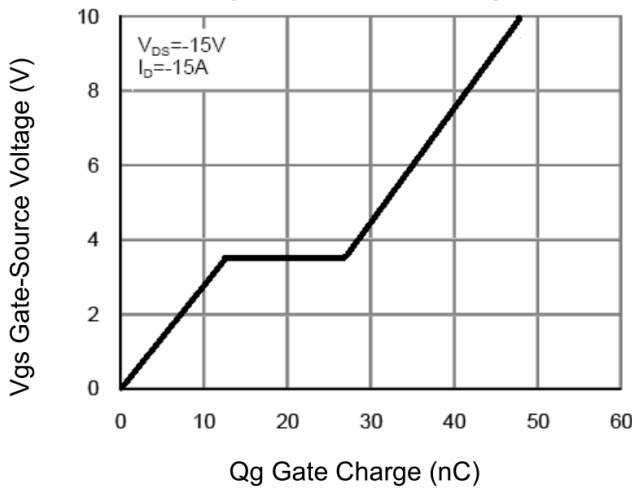

Figure 11 Gate Charge

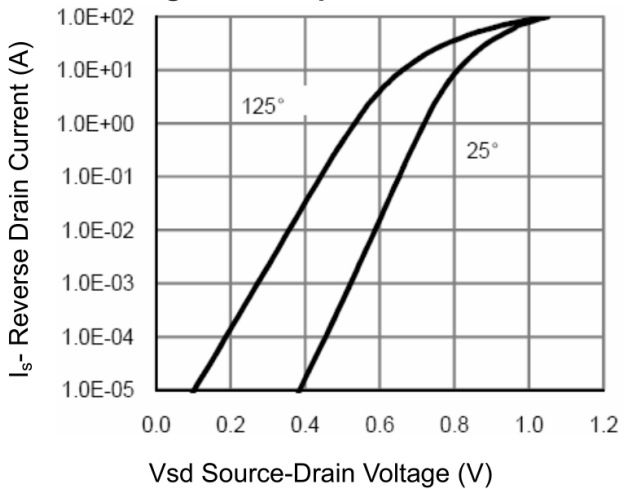

Figure 12 Source- Drain Diode Forward

Typical Characteristics

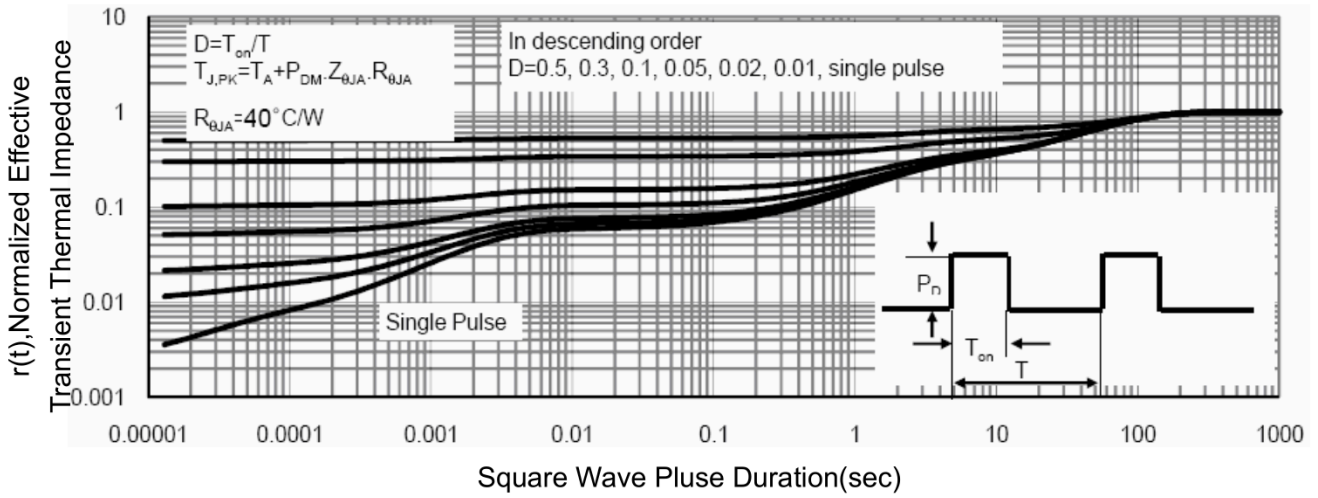
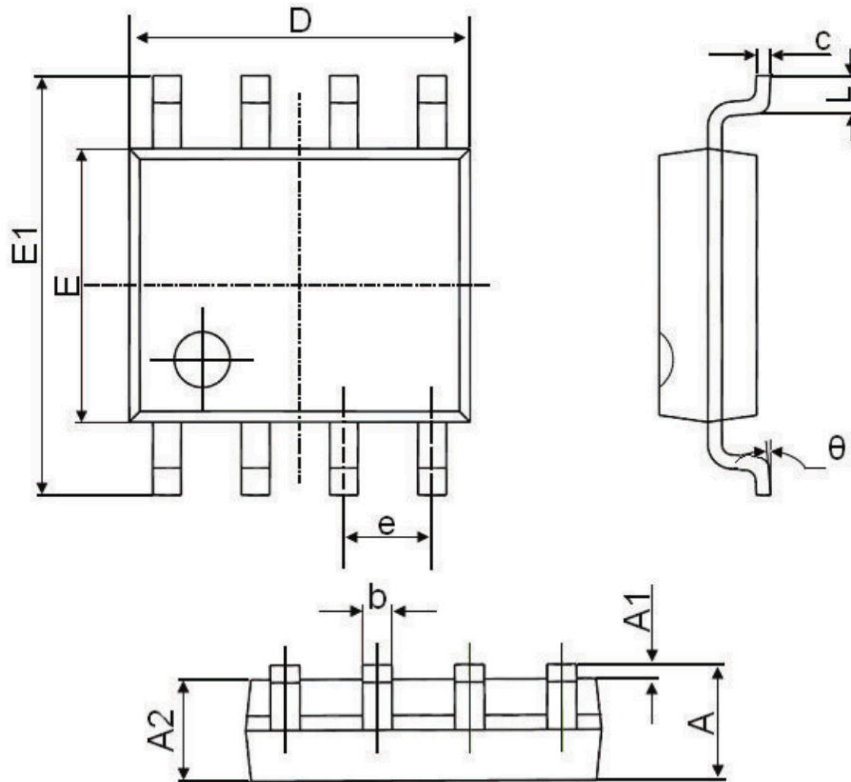

Figure 13 Normalized Maximum Transient Thermal Impedance

SOP-8 Package Information



Symbol	Dimensions In Millimeters		Dimensions In Inches	
	Min.	Max.	Min.	Max.
A	1.350	1.750	0.053	0.069
A1	0.100	0.250	0.004	0.010
A2	1.350	1.550	0.053	0.061
b	0.330	0.510	0.013	0.020
c	0.170	0.250	0.006	0.010
D	4.700	5.100	0.185	0.200
E	3.800	4.000	0.150	0.157
E1	5.800	6.200	0.228	0.244
e	1.270(BSC)		0.050(BSC)	
L	0.400	1.270	0.016	0.050
θ	0°	8°	0°	8°