

Product Summary

$V_{(BR)DSS}$	$R_{DS(on)MAX}$	I_D
60V	14mΩ@10V	30A
	17.5mΩ@4.5V	

Feature

- Excellent gate charge x RDS(on) product(FOM)
- Very low on-resistance RDS(on)
- 150 °C operating temperature
- Pb-free lead plating

Application

- DC/DC Converter
- Ideal for high-frequency switching and synchronous rectification

Package

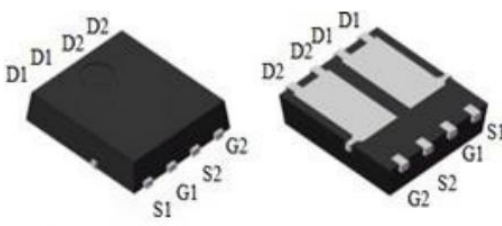

DFN5X6-8L

Circuit diagram

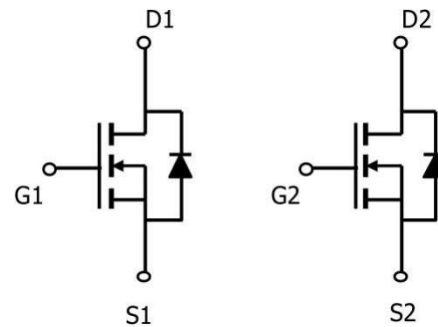

Marking



Absolute maximum ratings (T_c=25°C unless otherwise noted)

Parameter	Symbol	Value	Unit
Drain-Source Voltage	V _{DS}	60	V
Gate-Source Voltage	V _{GS}	±20	V
Continuous Drain Current	I _D	30	A
Continuous Drain Current(T _c =100°C)	I _D (100°C)	23.2	A
Pulsed Drain Current	I _{DM}	120	A
Power Dissipation	P _D	40	W
Thermal Resistance,Junction-to-Case ¹⁾	R _{θJC}	3.13	°C/W
Single pulse avalanche energy ⁴⁾	E _{AS}	135	mJ
Junction Temperature	T _J	150	°C
Storage Temperature	T _{STG}	-55 ~ +150	°C

Electrical characteristics (T_c=25°C unless otherwise noted)

Parameter	Symbol	Test Condition	Min	Typ	Max	Unit
Static Characteristics						
Drain-source breakdown voltage	V _{(BR)DSS}	V _{GS} = 0V, I _D =250μA	60			V
Zero gate voltage drain current	I _{DSS}	V _{DS} =60V, V _{GS} = 0V			1	μA
Gate-body leakage current	I _{GSS}	V _{GS} =±20V, V _{DS} = 0V			±100	nA
Gate threshold voltage ²⁾	V _{GS(th)}	V _{DS} =V _{GS} , I _D =250μA	1.2	1.7	2.2	V
Drain-source on-resistance ²⁾	R _{DS(on)}	V _{GS} =10V, I _D =15A		12	14	mΩ
		V _{GS} =4.5V, I _D =15A		15	17.5	
Dynamic characteristics³⁾						
Input Capacitance	C _{iss}	V _{DS} =30V, V _{GS} =0V, f =1MHz		1010		pF
Output Capacitance	C _{oss}			183.2		
Reverse Transfer Capacitance	C _{rss}			9.9		
Total Gate Charge	Q _g	V _{DS} =30V, V _{GS} =10V, I _D =15A		21.8		nC
Gate-Source Charge	Q _{gs}			4.6		
Gate-Drain Charge	Q _{gd}			3.5		
Turn-on delay time	t _{d(on)}	V _{DD} =30V, V _{GS} =10V, I _D =15A, R _G =1.6Ω		11		nS
Turn-on rise time	t _r			17		
Turn-off delay time	t _{d(off)}			18		
Turn-off fall time	t _f			4		
Source-Drain Diode characteristics						
Diode Forward Current ¹⁾	I _S				30	A
Diode Forward voltage ²⁾	V _{SD}	V _{GS} =0V, I _S =15A			1.2	V
Reverse Recovery Time	t _{rr}	T _J = 25°C, I _F = I _S di/dt = 100A/μs		30		nS
Reverse Recovery Charge	Q _{rr}			36		nC

Notes:

- 1) Surface Mounted on FR4 Board, t ≤ 10 sec.
- 2) Pulse Test: Pulse Width ≤ 300μs, Duty Cycle ≤ 2%.
- 3) Guaranteed by design, not subject to production.
- 4) EAS condition : T_J=25 ,V °C DD=30V,V_G=10V,L=0.5mH,R_G=25Ω.

Typical Characteristics

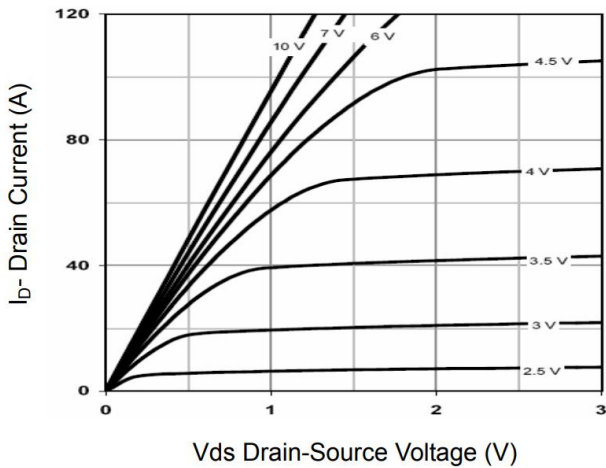

Figure 1 Output Characteristics

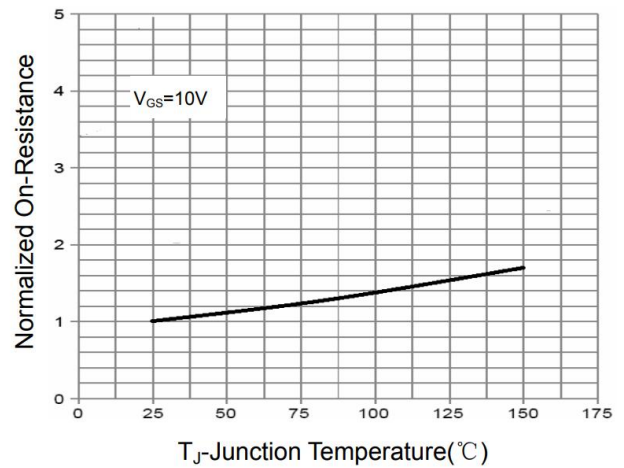

Figure 2 Rdson-Junction Temperature

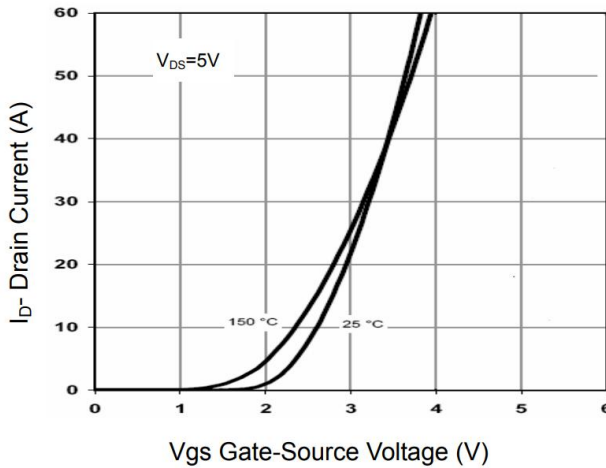

Figure 3 Transfer Characteristics

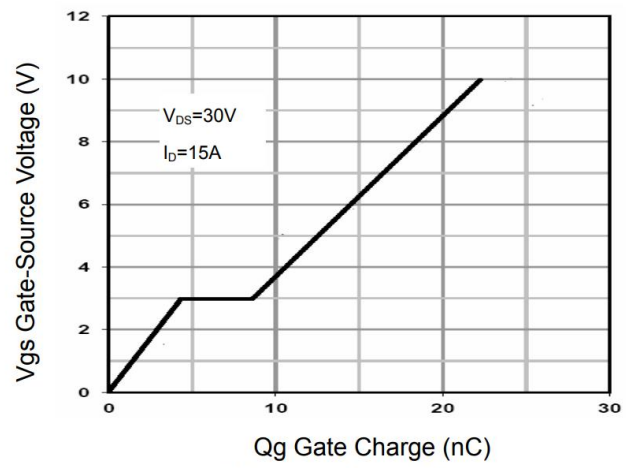

Figure 4 Gate Charge

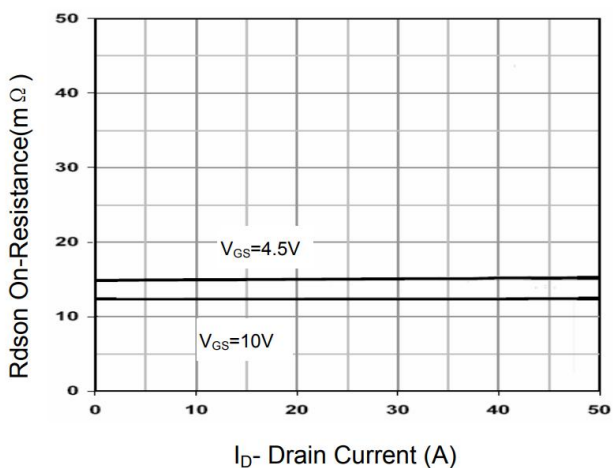

Figure 5 Rdson- Drain Current

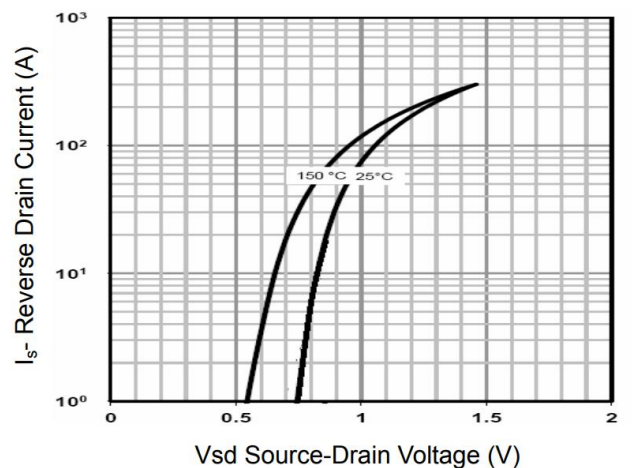
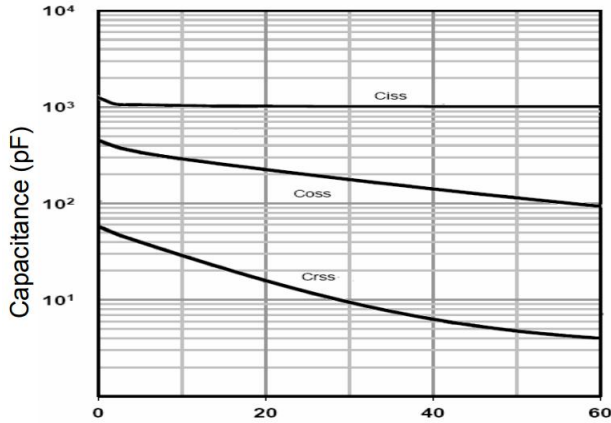
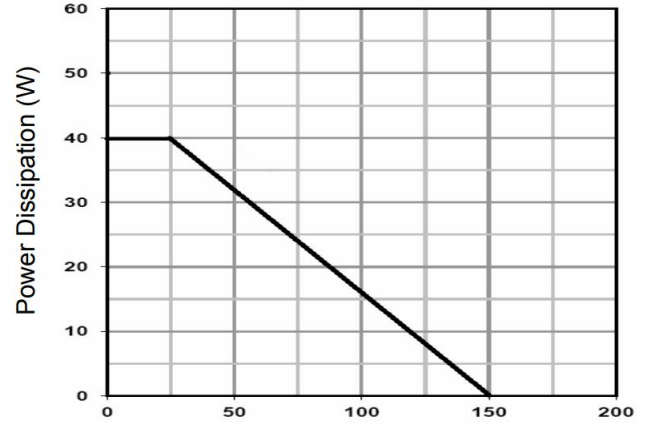

Figure 6 Source- Drain Diode Forward

Typical Characteristics



Vds Drain-Source Voltage (V)
Figure 7 Capacitance vs Vds



T_J-Junction Temperature(°C)
Figure 8 Power De-rating

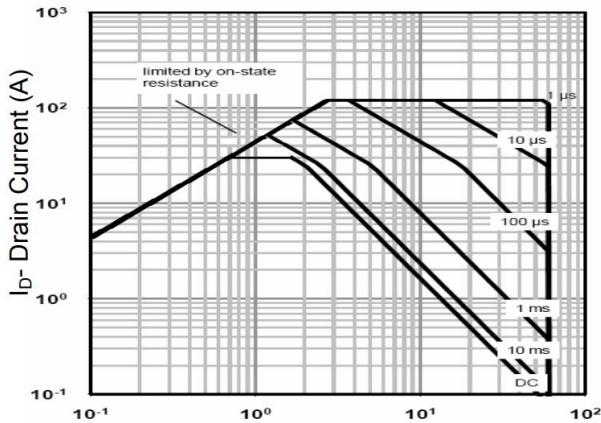

Vds Drain-Source Voltage (V)
Figure 9 Safe Operation Area

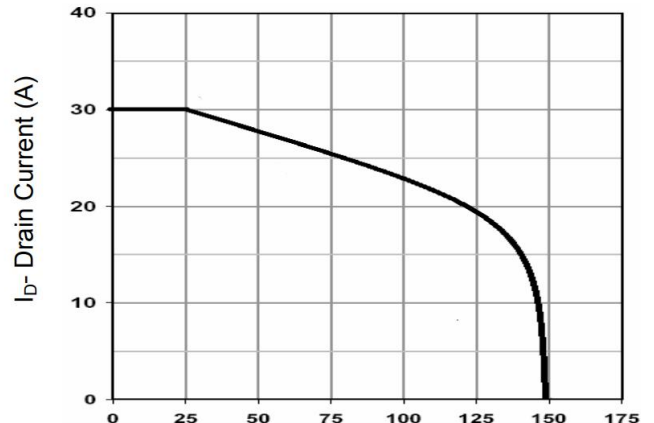

T_J-Junction Temperature (°C)
Figure 10 Current De-rating

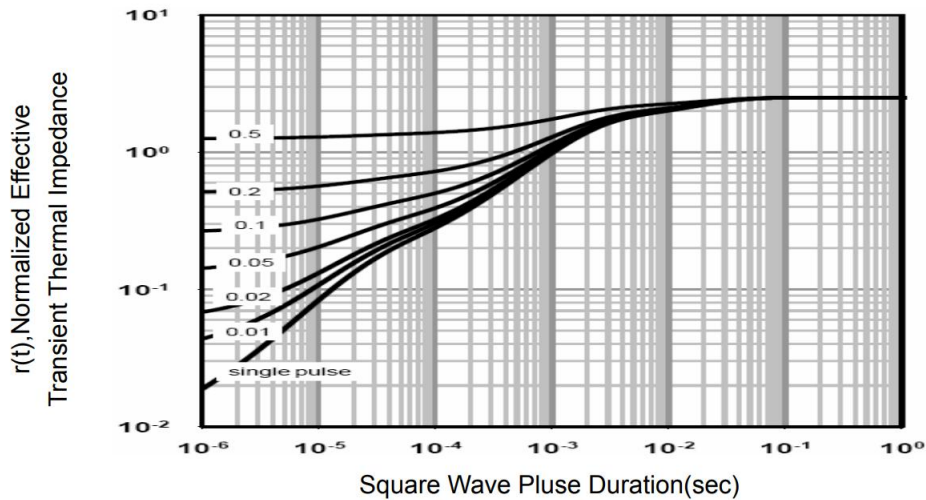
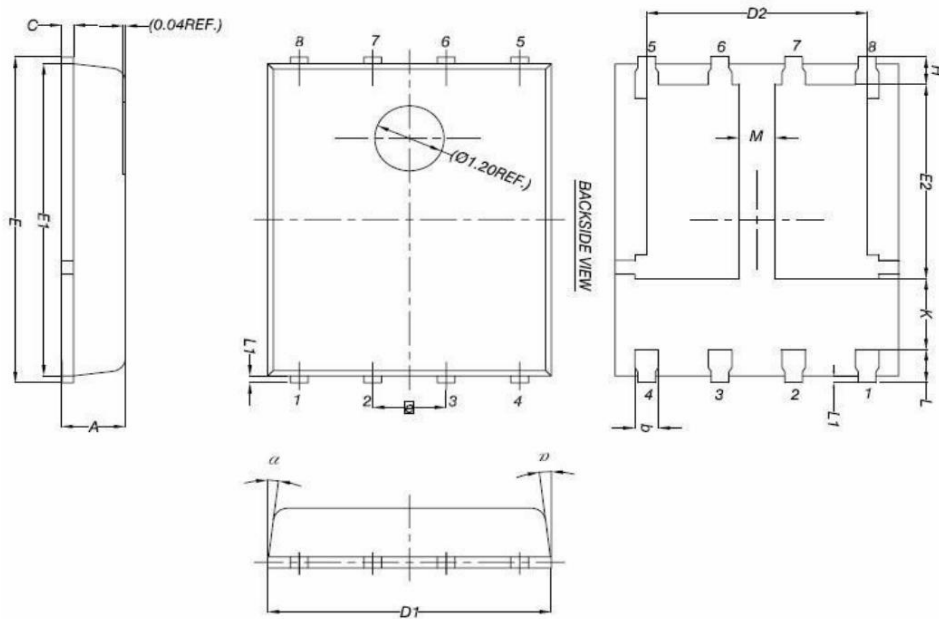

Figure 11 Normalized Maximum Transient Thermal Impedance

DFN5X6-8L Package Information



Symbol	Dimensions In Millimeters		Dimensions In Inches	
	Min.	Max.	Min.	Max.
A	0.90	1.10	0.035	0.043
b	0.33	0.51	0.013	0.020
C	0.20	0.30	0.008	0.012
D1	4.80	5.00	0.189	0.197
D2	3.61	3.96	0.142	0.156
E	5.90	6.10	0.232	0.240
E1	5.70	5.90	0.224	0.232
E2	3.37	3.78	0.133	0.149
e	1.27BSC.		1.27BSC.	
H	0.41	0.61	0.016	0.024
K	1.10	-	0.043	-
L	0.51	0.71	0.020	0.028
L1	0.06	0.20	0.002	0.008
M	0.50	-	0.020	-
a	0°	12°	0°	12°