

Product Summary

$V_{(BR)DSS}$	$R_{DS(on)MAX}$	I_D	$V_{(BR)DSS}$	$R_{DS(on)MAX}$	I_D
20V	35mΩ@4.5V	3A	-20V	75mΩ@-4.5V	-3A
	55mΩ@2.5V			100mΩ@-2.5V	

Feature

- Advanced trench process technology
- High density cell design for ultra low on-resistance

Application

- Battery protection
- Switching application

Package

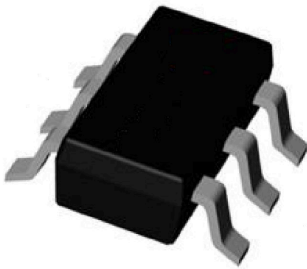

SOT-23-6L

Circuit diagram

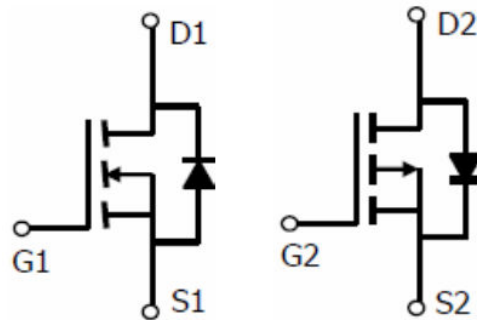

Marking

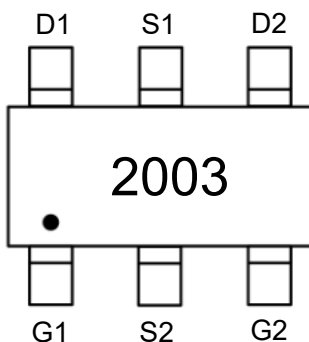

Absolute maximum ratings (Ta=25°C unless otherwise noted)

Parameter	Symbol	N-Channel	p-Channel	Unit
Drain-Source Voltage	V _{DS}	20	-20	V
Gate-Source Voltage	V _{GS}	±12	±12	V
Continuous Drain Current	I _D	3	-3	A
Pulsed Drain Current	I _{DM}	13	-13	A
Power Dissipation	P _D	0.8	0.8	W
Thermal Resistance from Junction to Ambient	R _{θJA}	156	156	°C/W
Junction Temperature	T _J	150	150	°C
Storage Temperature	T _{STG}	-55 ~ +150	-55 ~ +150	°C

N-CH Electrical characteristics (T_A=25 °C, unless otherwise noted)

Parameter	Symbol	Test Condition	Min.	Typ.	Max.	Unit
Static Characteristics						
Drain-source breakdown voltage	V _{(BR)DSS}	V _{GS} = 0V, I _D = 250μA	20			V
Zero gate voltage drain current	I _{DSS}	V _{DS} = 20V, V _{GS} = 0V			1	μA
Gate-body leakage current	I _{GSS}	V _{GS} = ±12V, V _{DS} = 0V			±100	nA
Gate threshold voltage	V _{GS(th)}	V _{DS} = V _{GS} , I _D = 250μA	0.5		1.2	V
Drain-source on-resistance ¹⁾	R _{DS(on)}	V _{GS} = 4.5V, I _D = 3.0A			35	mΩ
		V _{GS} = 2.5V, I _D = 2.8A			55	
Forward transconductance ¹⁾	g _{FS}	V _{DS} = 5V, I _D = 3A		8		S
Dynamic characteristics²⁾						
Input Capacitance	C _{iss}	V _{DS} = 10V, V _{GS} = 0V, f = 1MHz		260		pF
Output Capacitance	C _{oss}			48		
Reverse Transfer Capacitance	C _{rss}			27		
Total Gate Charge	Q _g	V _{DS} = 10V, V _{GS} = 4.5V, I _D = 3A		2.9		nC
Gate-Source Charge	Q _{gs}			0.4		
Gate-Drain Charge	Q _{gd}			0.6		
Turn-on delay time	t _{d(on)}	V _{DD} = 10V, V _{GS} = 4.5V, R _{GEN} = 6Ω, R _L = 3.3Ω		2.5		nS
Turn-on rise time	t _r			3.2		
Turn-off delay time	t _{d(off)}			21		
Turn-off fall time	t _f			3		
Source-Drain Diode characteristics						
Diode Forward Current ¹⁾	I _S				3	A
Diode Forward voltage	V _{DS}	V _{GS} = 0V, I _S = 3A			1.2	V

P-CH Electrical characteristics (TA=25 °C, unless otherwise noted)

Parameter	Symbol	Test Condition	Min.	Typ.	Max.	Unit
Static Characteristics						
Drain-source breakdown voltage	$V_{(BR)DSS}$	$V_{GS} = 0V, I_D = -250\mu A$	-20			V
Zero gate voltage drain current	I_{DSS}	$V_{DS} = -20V, V_{GS} = 0V$			-1	μA
Gate-body leakage current	I_{GSS}	$V_{GS} = \pm 12V, V_{DS} = 0V$			± 100	nA
Gate threshold voltage	$V_{GS(th)}$	$V_{DS} = V_{GS}, I_D = -250\mu A$	-0.4		-1.0	V
Drain-source on-resistance ¹⁾	$R_{DS(on)}$	$V_{GS} = -4.5V, I_D = -2.5A$			75	m Ω
		$V_{GS} = -2.5V, I_D = -2.0A$			100	
Forward transconductance ¹⁾	g_{FS}	$V_{DS} = -5V, I_D = -2.5A$		9.5		S
Dynamic characteristics²⁾						
Input Capacitance	C_{iss}	$V_{DS} = -10V, V_{GS} = 0V, f = 1MHz$		325		pF
Output Capacitance	C_{oss}			63		
Reverse Transfer Capacitance	C_{rss}			37		
Total Gate Charge	Q_g	$V_{DS} = -10V, V_{GS} = -4.5V, I_D = -2A$		3.2		nC
Gate-Source Charge	Q_{gs}			0.6		
Gate-Drain Charge	Q_{gd}			0.9		
Turn-on delay time	$t_{d(on)}$	$V_{DD} = -10V, V_{GS} = -4.5V, R_L = 5\Omega, R_{GEN} = 3\Omega$		11		nS
Turn-on rise time	t_r			5.5		
Turn-off delay time	$t_{d(off)}$			22		
Turn-off fall time	t_f			8		
Source-Drain Diode characteristics						
Diode Forward Current ¹⁾	I_S				-3	A
Diode Forward voltage	V_{DS}	$V_{GS} = 0V, I_S = -3A$			-1.2	V

Notes:

1) Pulse Test: Pulse Width < 300 μs , Duty Cycle $\leq 2\%$.

Guaranteed by design, not subject to production testing.

N- Channel Typical Electrical and Thermal Characteristics (Curves)

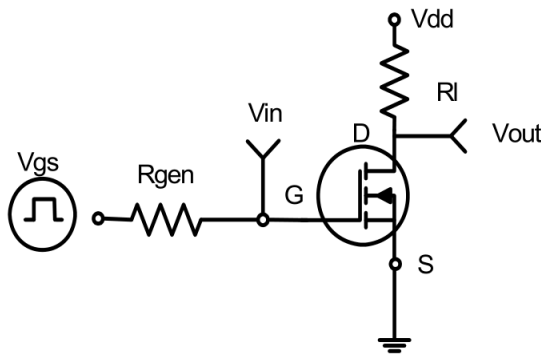

Figure 1: Switching Test Circuit

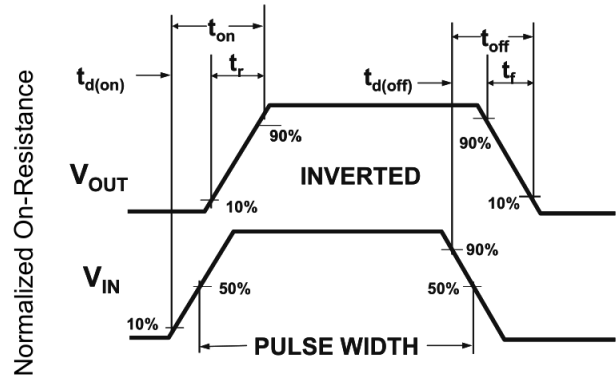

Figure 2: Switching Waveforms

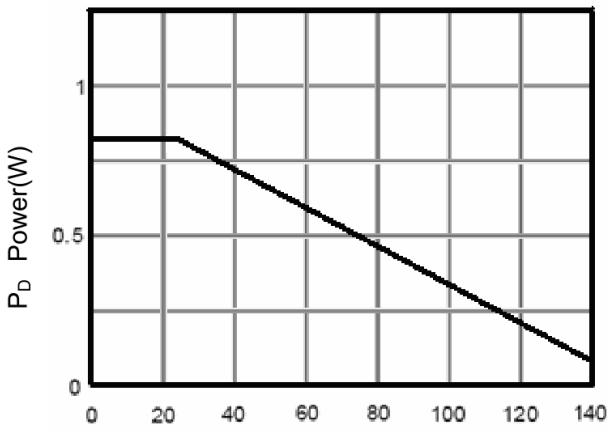

Figure 3 Power Dissipation

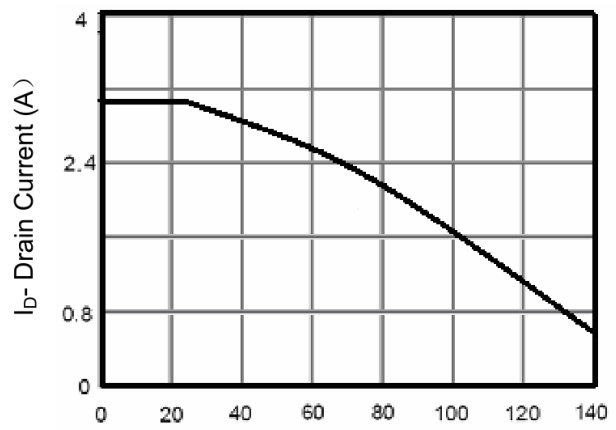

Figure 4 Drain Current

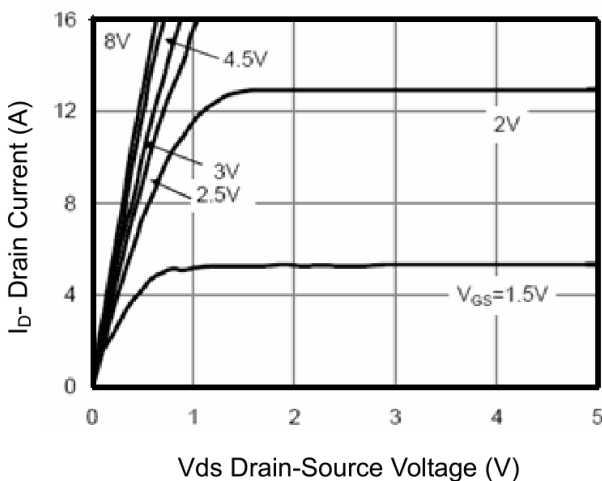

Figure 5 Output Characteristics

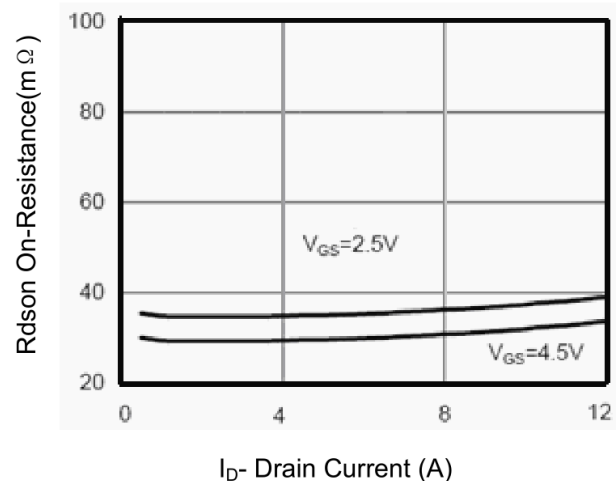

Figure 6 Drain-Source On-Resistance

N- Channel Typical Electrical and Thermal Characteristics (Curves)

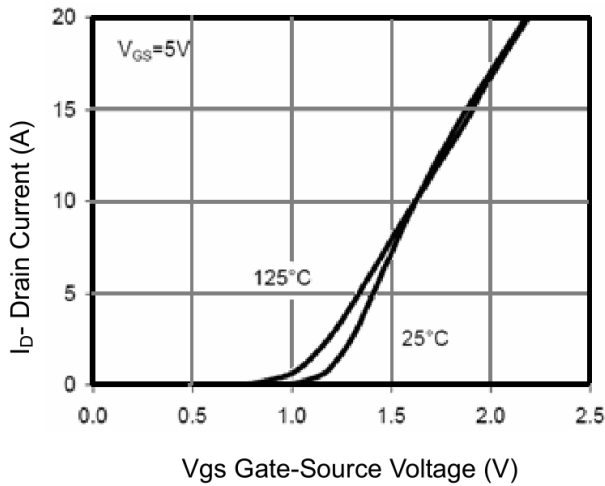

Figure 7 Transfer Characteristics

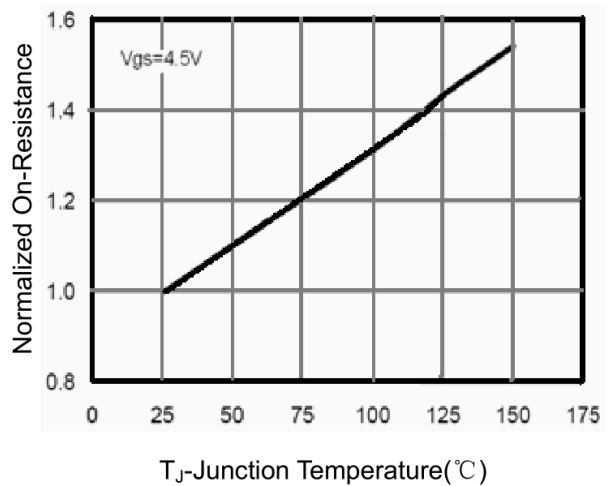

Figure 8 Drain-Source On-Resistance

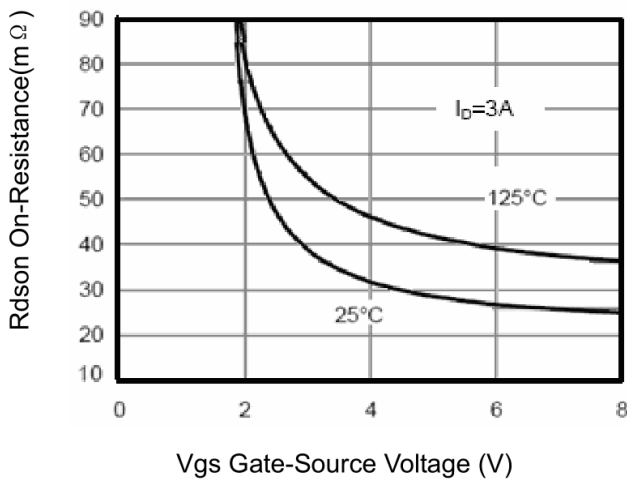

Figure 9 Rdson vs Vgs

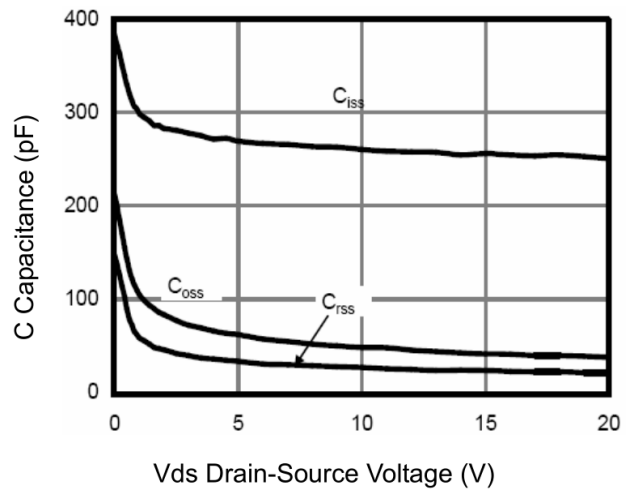

Figure 10 Capacitance vs Vds

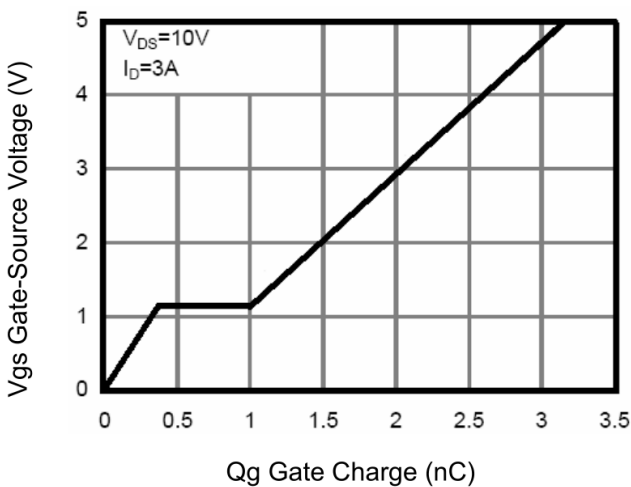

Figure 11 Gate Charge

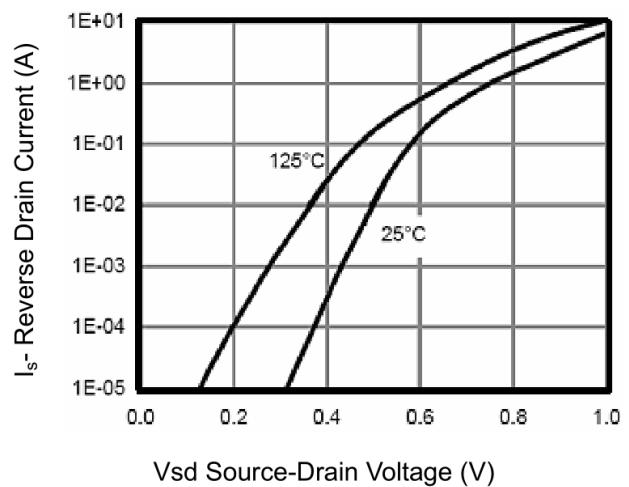

Figure 12 Source- Drain Diode Forward

N- Channel Typical Electrical and Thermal Characteristics (Curves)

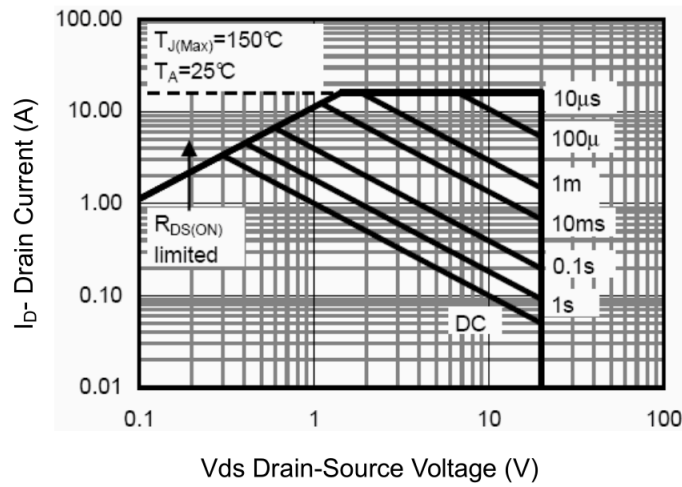

Figure 13 Safe Operation Area

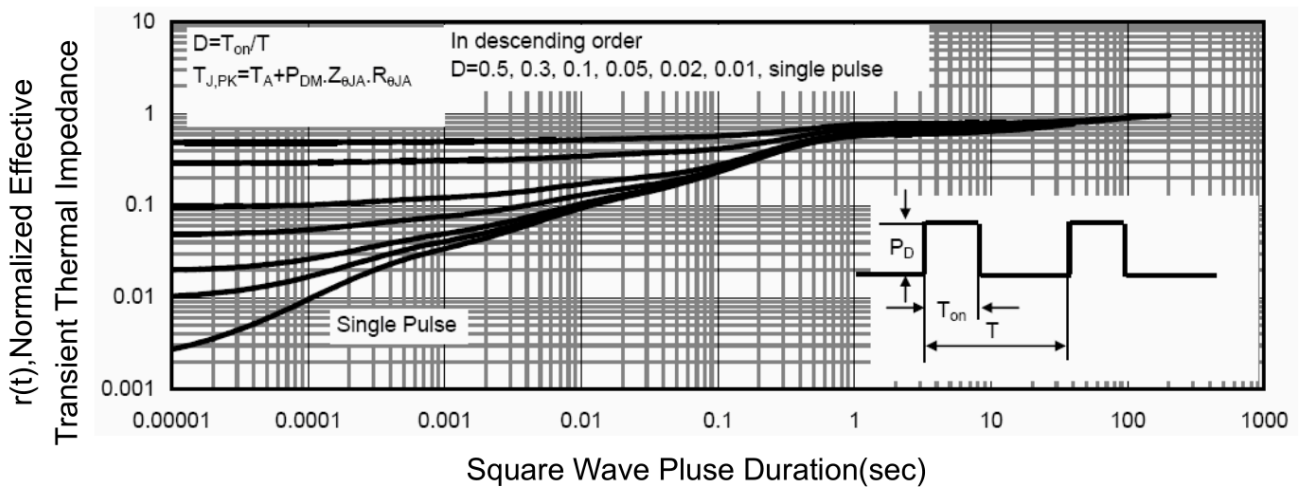

Figure 14 Normalized Maximum Transient Thermal Impedance

P- Channel Typical Electrical and Thermal Characteristics (Curves)

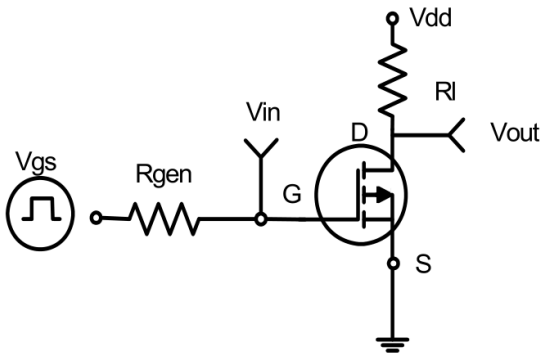

Figure 1: Switching Test Circuit

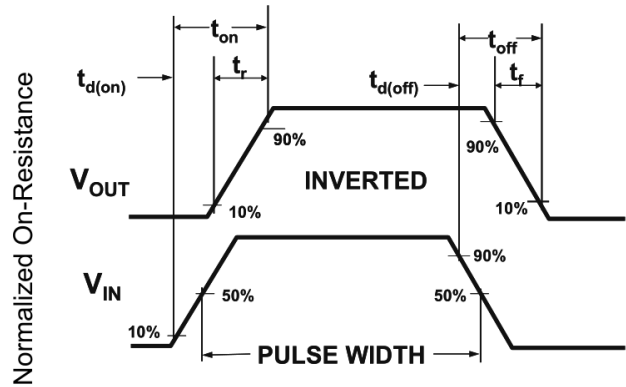

Figure 2: Switching Waveforms

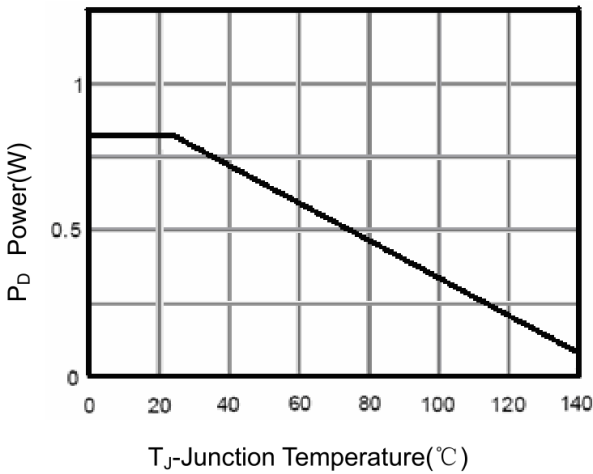

Figure 3 Power Dissipation

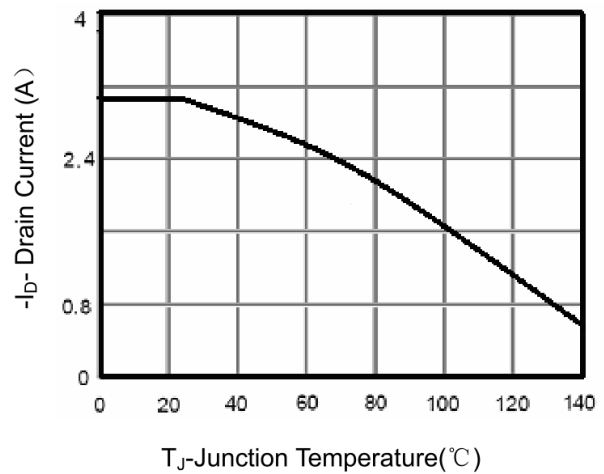

Figure 4 Drain Current

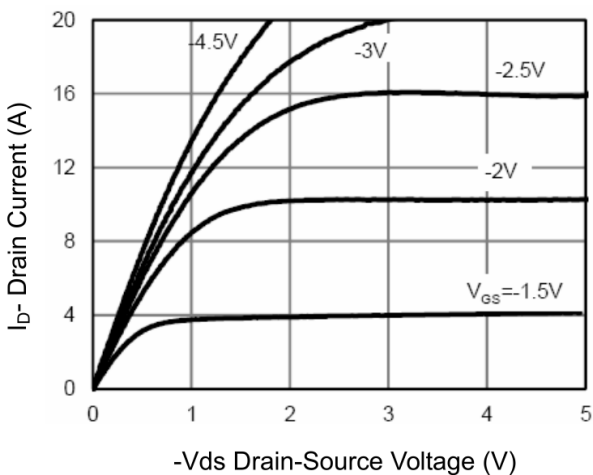

Figure 5 Output Characteristics

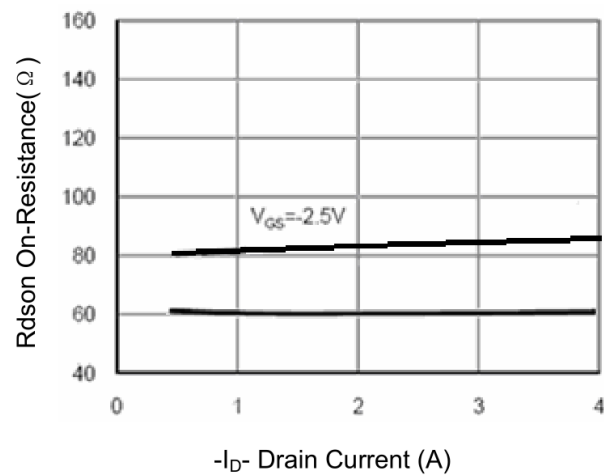

Figure 6 Drain-Source On-Resistance

P- Channel Typical Electrical and Thermal Characteristics (Curves)

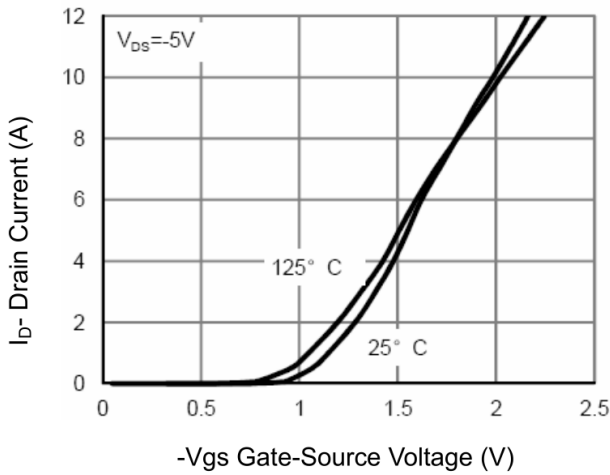

Figure 7 Transfer Characteristics

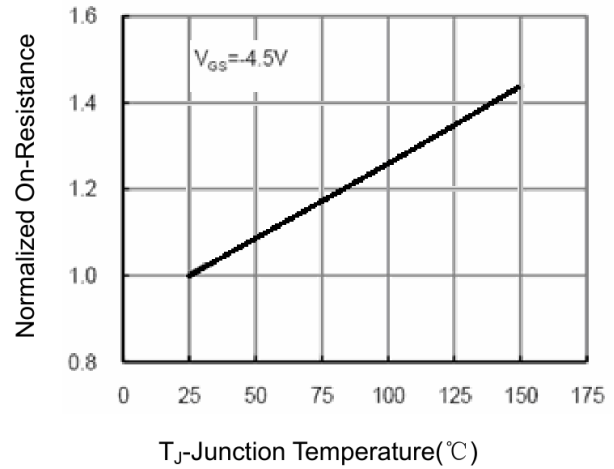

Figure 8 Drain-Source On-Resistance

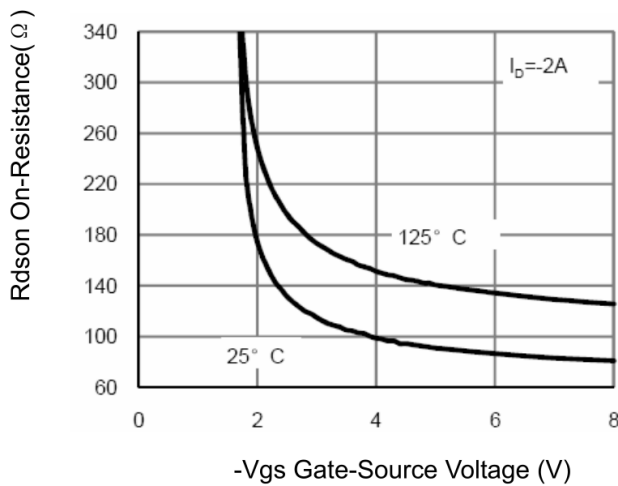

Figure 9 Rdson vs Vgs

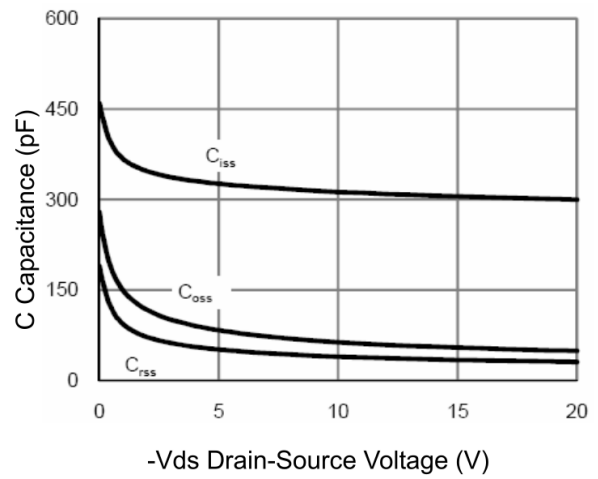

Figure 10 Capacitance vs Vds

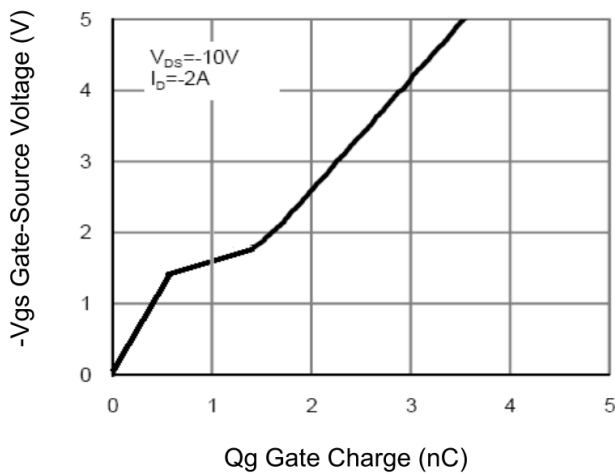

Figure 11 Gate Charge

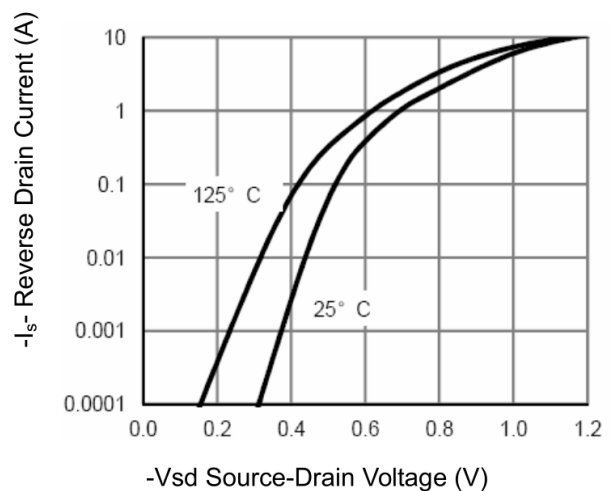

Figure 12 Source- Drain Diode Forward

P- Channel Typical Electrical and Thermal Characteristics (Curves)

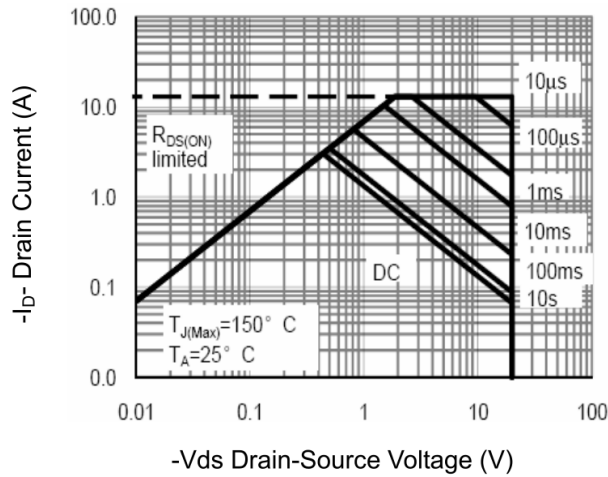

Figure 13 Safe Operation Area

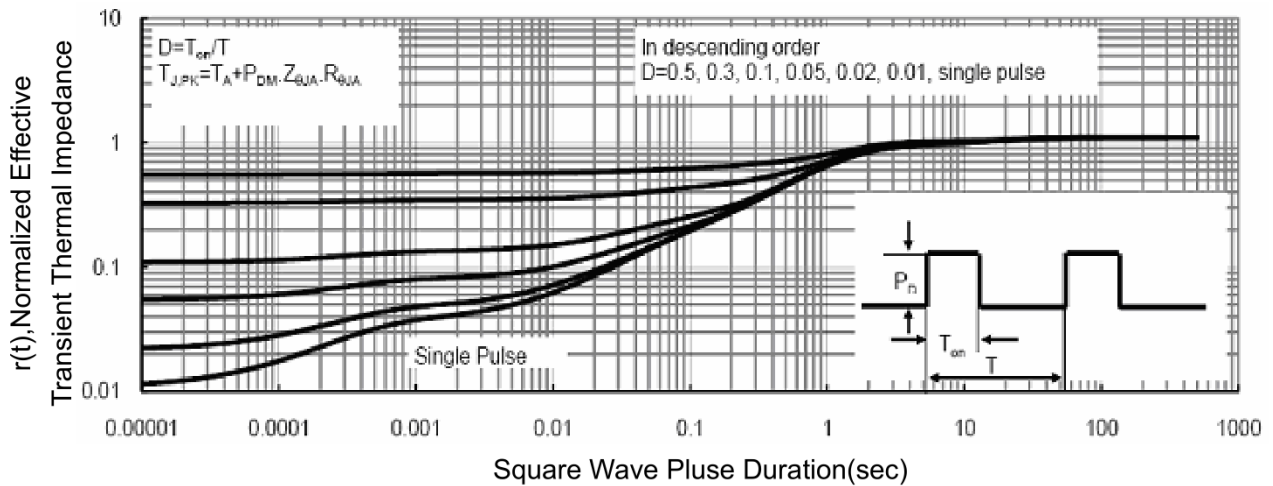
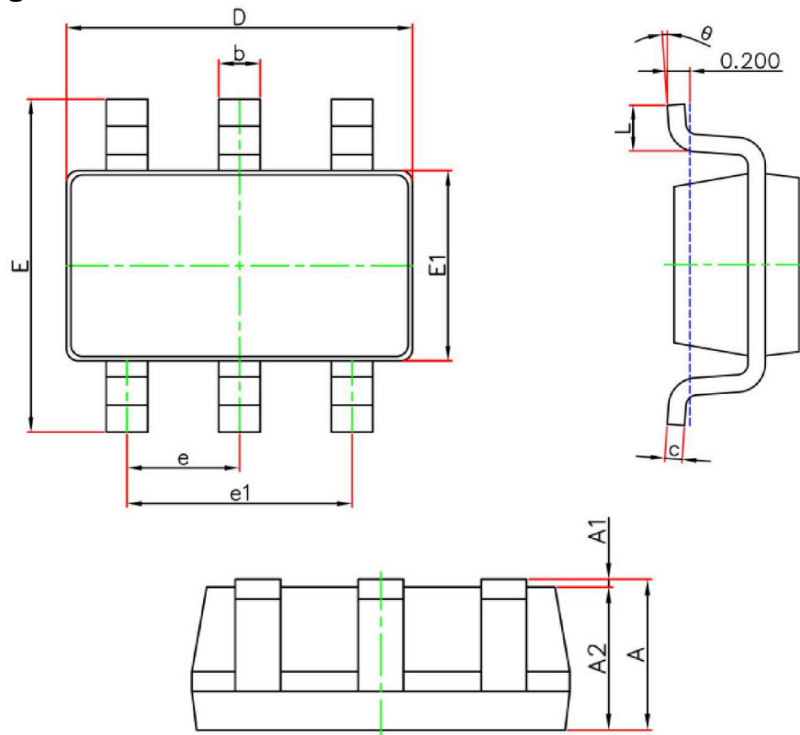

Figure 14 Normalized Maximum Transient Thermal Impedance

SOT-23-6L Package Information



Symbol	Dimensions In Millimeters		Dimensions In Inches	
	Min.	Max.	Min.	Max.
A	1.050	1.250	0.041	0.049
A1	0.000	0.100	0.000	0.004
A2	1.050	1.150	0.041	0.045
b	0.300	0.500	0.012	0.020
c	0.100	0.200	0.004	0.008
D	2.820	3.020	0.111	0.119
E	2.650	2.950	0.104	0.116
E1	1.500	1.700	0.059	0.067
e	0.950 (BSC)		0.037 (BSC)	
e1	1.800	2.000	0.071	0.079
L	0.300	0.600	0.012	0.024
θ	0°	8°	0°	8°