

Product Summary

$V_{(BR)DSS}$	$R_{DS(on)MAX}$	$I_D@25^{\circ}C$
1200V	34mΩ@20V	65A

Feature

- High Blocking Voltage With Low On-Resistance
- High Speed Switching With Low Capacitance
- Easy to Parallel and Simple to Drive

Application

- Power Supplies
- Switch Mode Power Supplies
- High Voltage DC/DC Converters
- Motor Drivers
- Pulsed Power Applications

Package



TO-247-4

Marking



D S2 S1 G

Circuit diagram

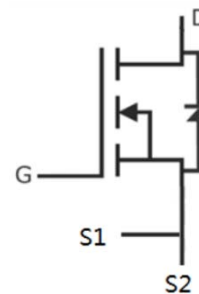

Absolute maximum ratings ($T_C=25^{\circ}C$ unless otherwise noted)

Parameter	Symbol	Test Condition	Value	Unit
Drain-Source Voltage	V_{DSmax}	$V_{GS} = 0V, I_{DS} = 100\mu A$	1200	V
Gate-Source Voltage	V_{GSmax}	Absolute maximum values	-10/+25	V
Gate-Source Voltage	V_{GSOP}	Recommended operational values	-5/+20	V
Continuous Drain Current	I_D	$V_{GS} = 20V, T_C = 25^{\circ}C$	65	A
	I_D	$V_{GS} = 20V, T_C = 100^{\circ}C$	43	A
Pulsed Drain Current	I_{DM}	Pulse width t_p limited by T_{jmax}	200	A
Power Dissipation	P_D	$T_C = 25^{\circ}C, T_J = 150^{\circ}C$	370	W
Thermal Resistance	$R_{\theta JC}$	Junction-to-Case	0.25	$^{\circ}C/W$
Thermal Resistance	$R_{\theta JA}$	Junction-to-Ambient	40	$^{\circ}C/W$
Junction Temperature	T_J		-55 ~ +150	$^{\circ}C$
Storage Temperature	T_{STG}		-55 ~ +150	$^{\circ}C$

Electrical characteristics (T_c=25 °C, unless otherwise noted)

Parameter	Symbol	Test Condition	Min.	Typ.	Max.	Unit
Static Characteristics						
Drain-source breakdown voltage	V _{(BR)DSS}	V _{GS} = 0V, I _{DS} = 100μA	1200			V
Zero gate voltage drain current	I _{DSS}	V _{DS} = 1200V, V _{GS} = 0V			100	μA
Gate-Source leakage current	I _{GSS+}	V _{GS} = 25V, V _{DS} = 0V			250	nA
Gate-Source leakage current	I _{GSS-}	V _{GS} = -10V, V _{DS} = 0V			250	nA
Gate threshold voltage	V _{GS(th)}	V _{DS} = V _{GS} , I _{DS} = 15mA	1.9	2.4	4.0	V
		V _{DS} = V _{GS} , I _{DS} = 15mA, T _J = 150°C		1.7		
Drain-source on-resistance	R _{DS(on)}	V _{GS} = 20V, I _D = 50A		25	34	mΩ
		V _{GS} = 20V, I _D = 50A, T _J = 150°C		43		
Dynamic characteristics						
Input Capacitance	C _{iss}	V _{DS} = 1000V, V _{GS} = 0V, f = 1MHz V _{AC} = 25mV		4200		pF
Output Capacitance	C _{oss}			250		
Reverse Transfer Capacitance	C _{rss}			16		
C _{oss} Stored Energy	E _{oss}			126		μJ
Turn-on Switching Energy	E _{on}	V _{DS} = 800V, V _{GS} = -5V/20V, I _D = 50A, R _{G(ext)} = 2.5Ω, L = 412μH		1.8		mJ
Turn-off Switching Energy	E _{off}			0.6		
Total Gate Charge	Q _g	V _{DS} = 800V, V _{GS} = -5V/20V, I _D = 50A		195		nC
Gate-Source Charge	Q _{gs}			54		
Gate-Drain Charge	Q _{gd}			29		
Turn-on delay time	t _{d(on)}	V _{DS} = 800V, V _{GS} = -5V/20V, I _D = 50A, R _{G(ext)} = 2.5Ω, R _L = 16Ω		15		nS
Turn-on rise time	t _r			12		
Turn-off delay time	t _{d(off)}			34		
Turn-off fall time	t _f			7		
Internal Gate Resistance	R _G	f = 1MHz, V _{AC} = 25mV		2.1		Ω
Source-Drain Diode characteristics						
Diode Forward Current	I _S	T _C = 25°C			98	A
Diode Forward voltage	V _{DS}	V _{GS} = -5V, I _F = 25A		3.5		V
		V _{GS} = -5V, I _F = 25A, T _J = 150°C		3.3		
Reverse Recovery Time	t _{rr}	I _{SD} = 50A, V _R = 800V		50		nS
Reverse Recovery Charge	Q _{rr}			216		nC
Peak Reverse Recovery Current	I _{rrm}				7.2	

Typical Characteristics

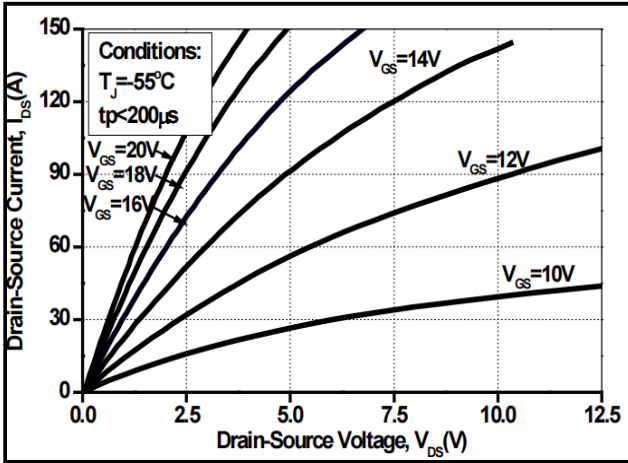

Figure 1. Output Characteristics $T_j = -55^\circ\text{C}$

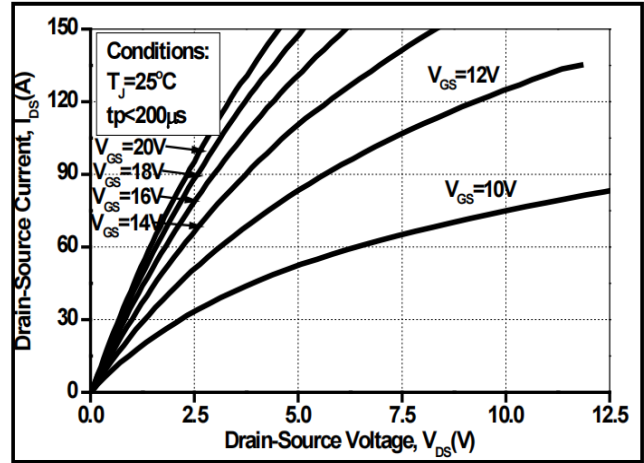

Figure 2. Output Characteristics $T_j = 25^\circ\text{C}$

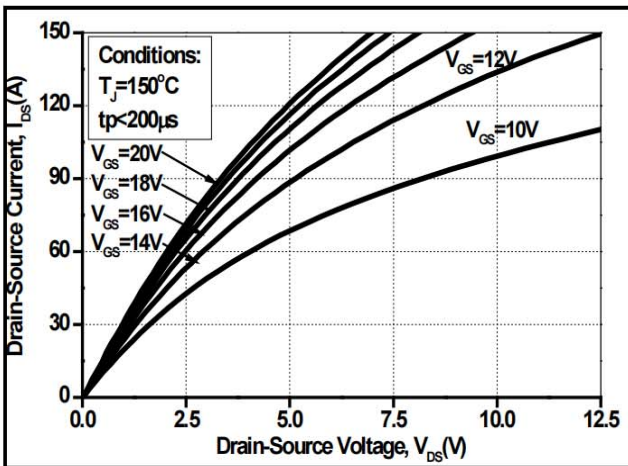

Figure 3. Output Characteristics $T_j = 150^\circ\text{C}$

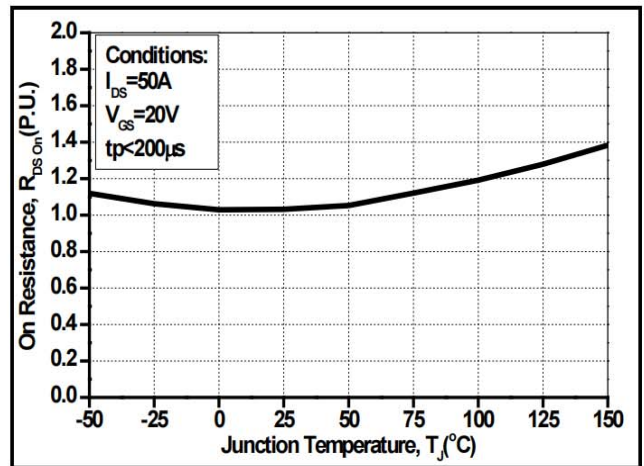

Figure 4. Normalized On-Resistance vs. Temperature

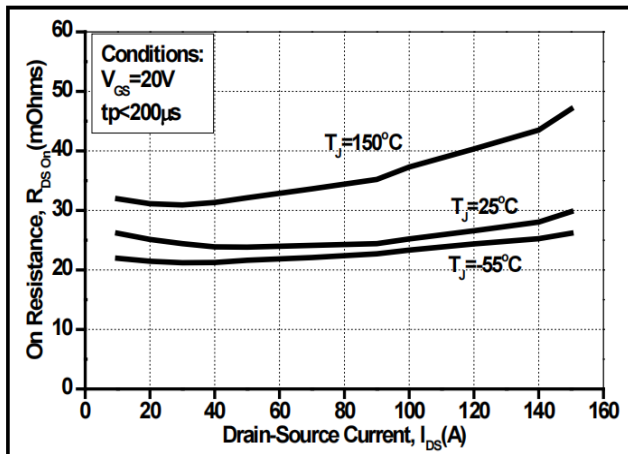

Figure 5. On-Resistance vs. Drain Current
For Various Temperatures

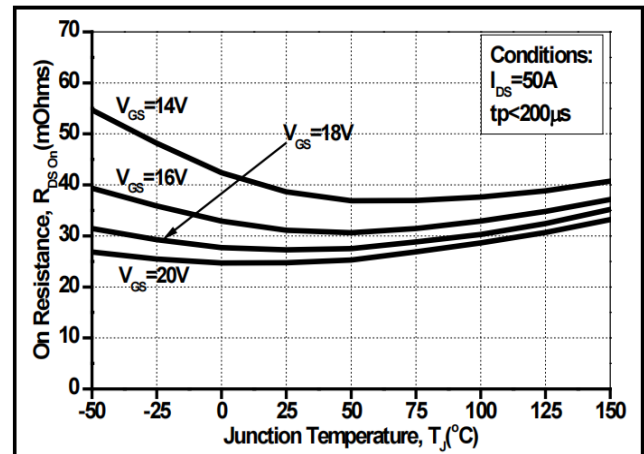

Figure 6. On-Resistance vs. Temperature
For Various Gate Voltage

Typical Characteristics

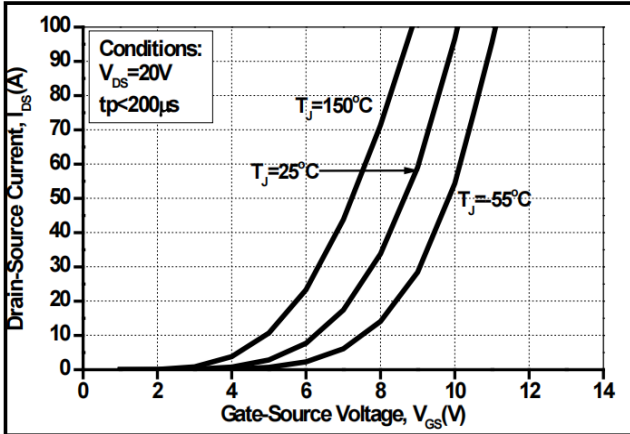

Figure 7. Transfer Characteristic for Various Junction Temperatures

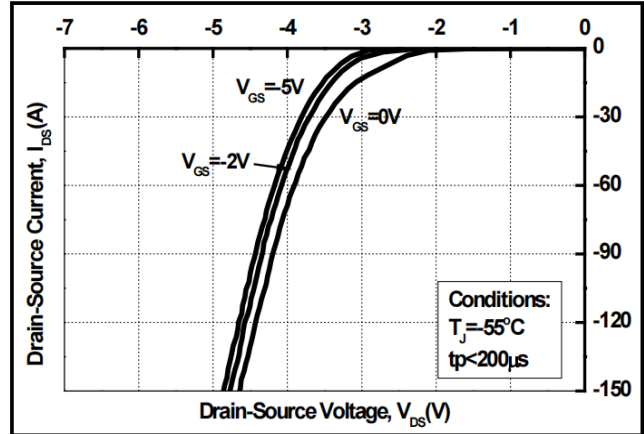

Figure 8. Body Diode Characteristic at -55°C

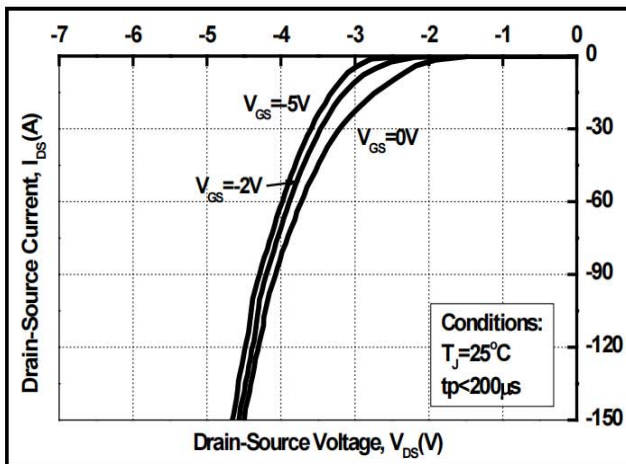

Figure 9. Body Diode Characteristic at 25°C

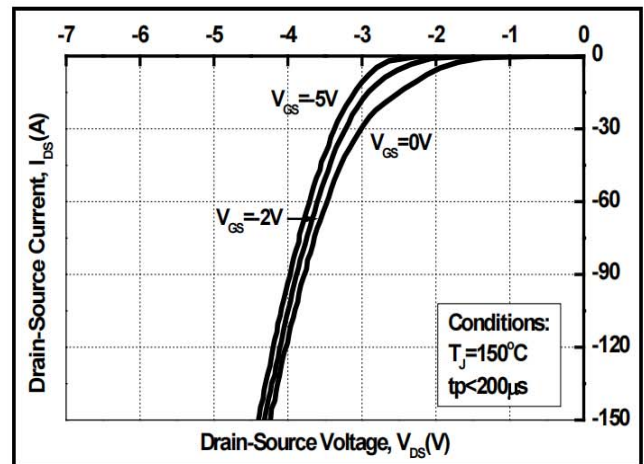

Figure 10. Body Diode Characteristic at 150°C

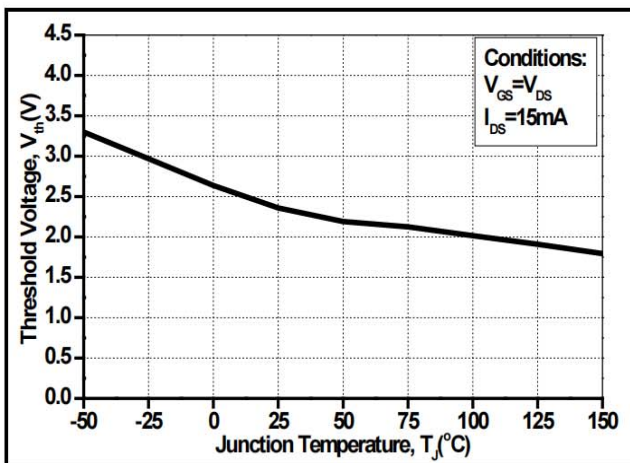

Figure 11. Threshold Voltage vs. Temperature

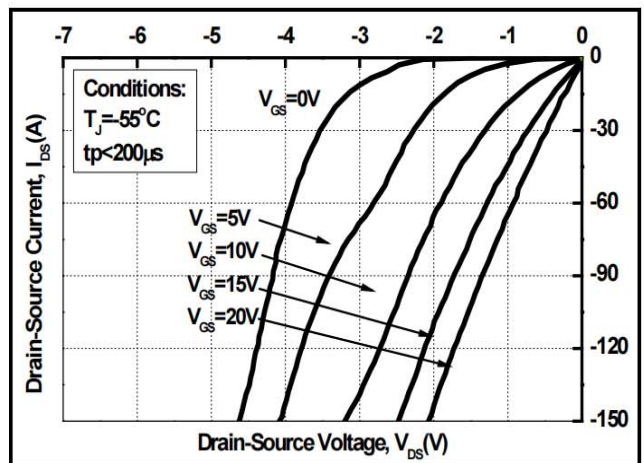

Figure 12. 3rd Quadrant Characteristic at -55°C

Typical Characteristics

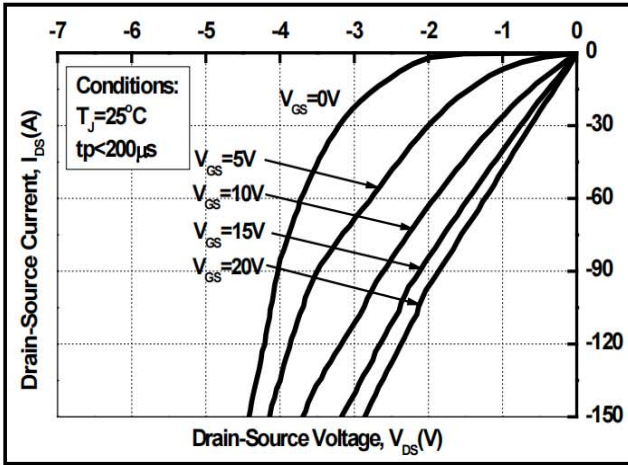

Figure 13. 3rd Quadrant Characteristic at 25°C

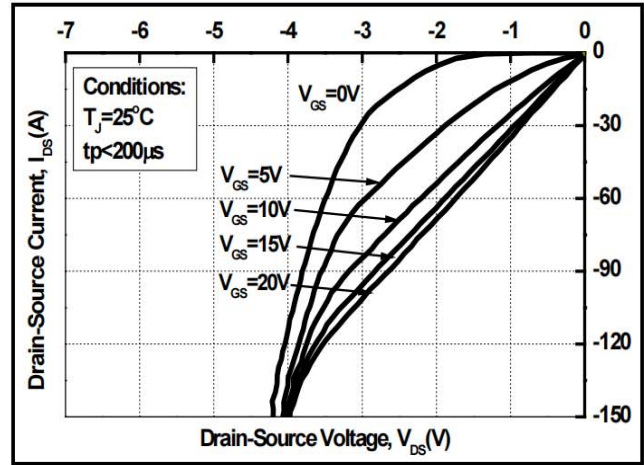

Figure 14. 3rd Quadrant Characteristic at 150°C

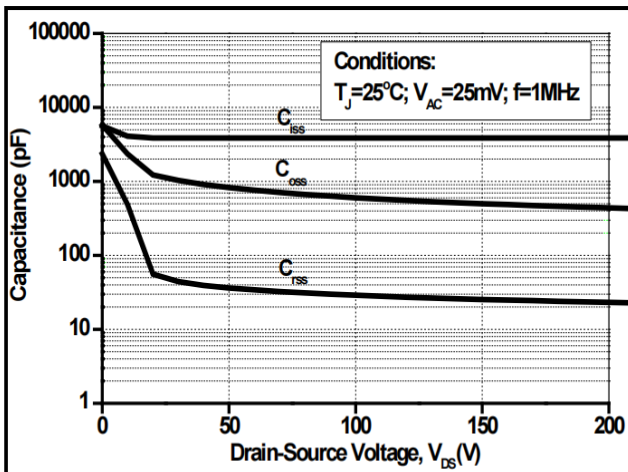

Figure 15. Capacitances vs. Drain-Source Voltage (0 - 200V)

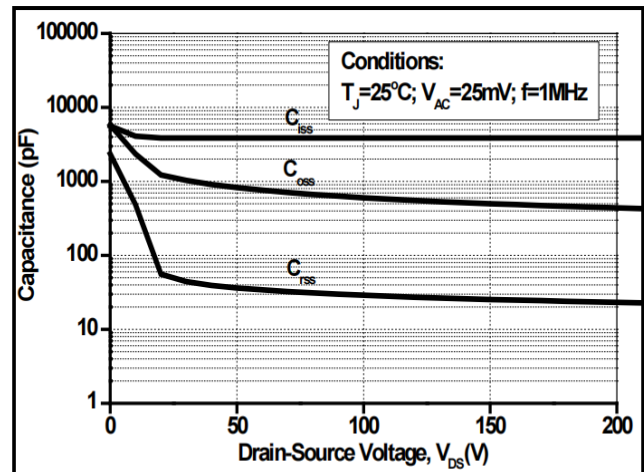
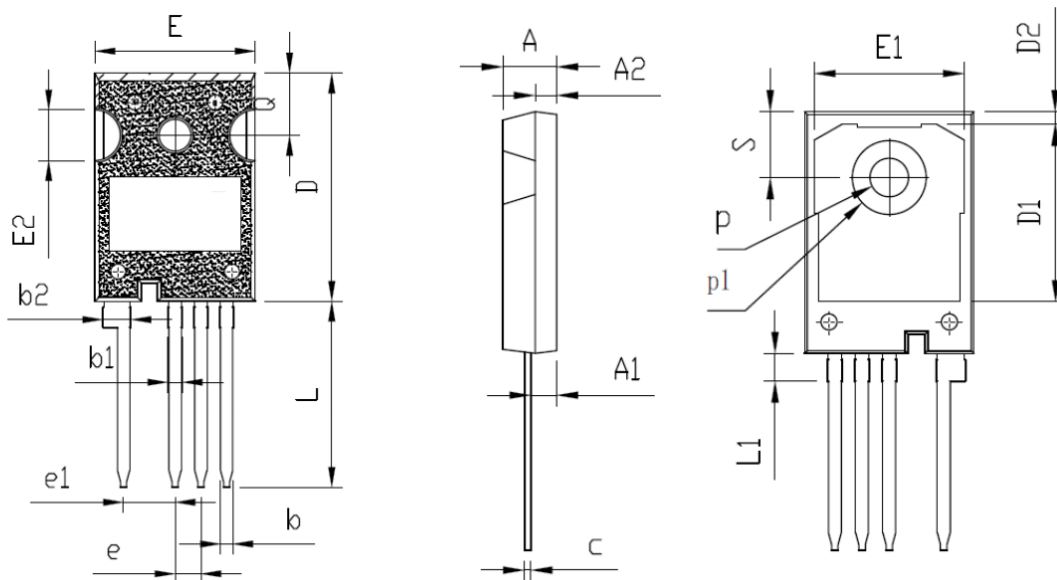

Figure 16. Capacitances vs. Drain-Source Voltage (0 - 1000V)

TO-247-4 Package Information



Symbol	Dimensions In Millimeters		Dimensions In Inches	
	Min.	Max.	Min.	Max.
A	4.800	5.250	0.189	0.207
A1	2.250	2.550	0.089	0.100
A2	1.900	2.200	0.075	0.087
b	1.050	1.350	0.041	0.053
b1	1.050	1.600	0.041	0.063
b2	2.350	2.950	0.093	0.116
c	0.550	0.700	0.022	0.028
D	23.200	23.800	0.913	0.937
D1	16.250	17.650	0.640	0.695
D2	0.950	1.250	0.037	0.049
E	15.700	16.200	0.618	0.638
E1	13.000	14.200	0.512	0.559
E2	3.650	5.200	0.144	0.205
L	17.300	19.850	0.681	0.781
L1	3.950	4.450	0.156	0.175
Q	5.450	6.300	0.215	0.248
S	6.000	6.300	0.236	0.248
P	3.500	3.650	0.138	0.144
P1	7.180 BSC		0.283 BSC	
e	2.540 BSC		0.100 BSC	
e1	5.080 BSC		0.2000 BSC	