

### Product Summary

$V_{(BR)DSS}$	$R_{DS(on)MAX}$	$I_D$
120V	7.6mΩ@10V	88A
	9.6mΩ@4.5V	

### Feature

- Split gate trench MOSFET technology
- Excellent package for heat dissipation
- High density cell design for low  $R_{DS(ON)}$
- Suffix "-Q1" for AEC-Q101

### Application

- Power switching application
- Uninterruptible power supply
- Hard switched and high frequency circuits

### Package

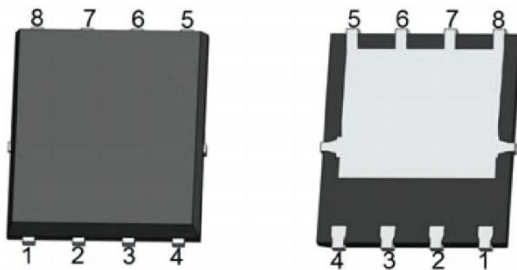

PDFN5\*6-8L

### Circuit diagram

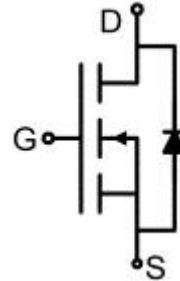

### Marking

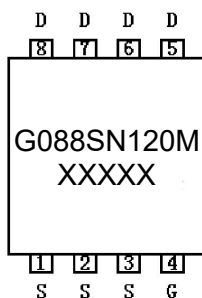

### Absolute maximum ratings (T<sub>A</sub>=25°C unless otherwise noted)

Parameter	Symbol	Value	Unit
Drain-Source Voltage	V <sub>DS</sub>	120	V
Gate-Source Voltage	V <sub>GS</sub>	±20	V
Continuous Drain Current (T <sub>C</sub> =25°C)	I <sub>D</sub>	88	A
Continuous Drain Current (T <sub>C</sub> =100°C)	I <sub>D(100°C)</sub>	56	A
Pulsed Drain Current <sup>1)</sup>	I <sub>DM</sub>	352	A
Single Pulse Avalanche Energy <sup>2)</sup>	E <sub>AS</sub>	400	mJ
Power Dissipation <sup>3)</sup> (T <sub>C</sub> =25°C)	P <sub>D</sub>	120	W
Thermal Resistance Junction to Case	R <sub>θJC</sub>	1.04	°C/W
Operating Junction Temperature	T <sub>J</sub>	-55 ~ +150	°C
Storage Temperature	T <sub>STG</sub>	-55 ~ +150	°C

### Electrical characteristics (T<sub>J</sub>=25 °C, unless otherwise noted)

Parameter	Symbol	Test Condition	Min.	Typ.	Max.	Unit
<b>Static Characteristics</b>						
Drain-source breakdown voltage	V <sub>(BR)DSS</sub>	V <sub>GS</sub> = 0V, I <sub>D</sub> = 250μA	120			V
Zero gate voltage drain current	I <sub>DSS</sub>	V <sub>DS</sub> = 120V, V <sub>GS</sub> = 0V			1	μA
Gate-body leakage current	I <sub>GSS</sub>	V <sub>DS</sub> = 0V, V <sub>GS</sub> = ±20V			±100	nA
Gate threshold voltage	V <sub>GS(th)</sub>	V <sub>DS</sub> = V <sub>GS</sub> , I <sub>D</sub> = 250μA	1	2	3	V
Drain-source on-resistance	R <sub>DS(on)</sub>	V <sub>GS</sub> = 10V, I <sub>D</sub> = 20A		6.4	7.6	mΩ
		V <sub>GS</sub> = 4.5V, I <sub>D</sub> = 20A		7.6	9.6	
<b>Dynamic characteristics<sup>4)</sup></b>						
Input Capacitance	C <sub>iss</sub>	V <sub>DS</sub> = 50V, V <sub>GS</sub> = 0V, f = 1MHz		4619		pF
Output Capacitance	C <sub>oss</sub>			924		
Reverse Transfer Capacitance	C <sub>rss</sub>			28		
Total Gate Charge	Q <sub>g</sub>	V <sub>DS</sub> = 50V, V <sub>GS</sub> = 10V, I <sub>D</sub> = 20A		72		nC
Gate-Source Charge	Q <sub>gs</sub>			19.5		
Gate-Drain Charge	Q <sub>gd</sub>			8.2		
Turn-on delay time	t <sub>d(on)</sub>	V <sub>DS</sub> = 50V, V <sub>GS</sub> = 10V, I <sub>D</sub> = 20A R <sub>G</sub> = 2.2Ω		19		nS
Turn-on rise time	t <sub>r</sub>			36		
Turn-off delay time	t <sub>d(off)</sub>			45		
Turn-off fall time	t <sub>f</sub>			45		
<b>Source-Drain Diode characteristics</b>						
Diode Forward Current	I <sub>S</sub>				88	A
Diode Forward voltage	V <sub>SD</sub>	V <sub>GS</sub> = 0V, I <sub>S</sub> = 20A			1.3	V
Reverse Recovery Time	T <sub>rr</sub>	I <sub>F</sub> = 20A, di/dt = -100A/μs		195		nS
Reverse Recovery Charge	Q <sub>rr</sub>			86		nC

Notes:

- 1) Repetitive rating; pulse width limited by max. junction temperature.
- 2) T<sub>J</sub>=25°C, V<sub>DD</sub>=50V, V<sub>G</sub>=10V, R<sub>G</sub>=25Ω, L=2mH, I<sub>AS</sub>=20A.
- 3) P<sub>d</sub> is based on max. junction temperature, using junction-case thermal resistance.
- 4) Guaranteed by design, not subject to production testing.

## Typical Characteristics

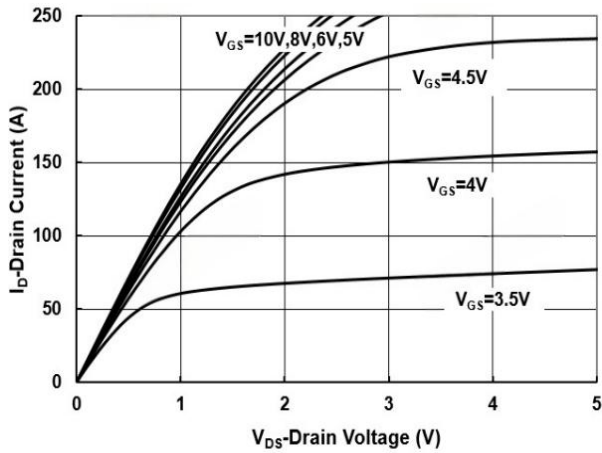

Figure1. Output Characteristics

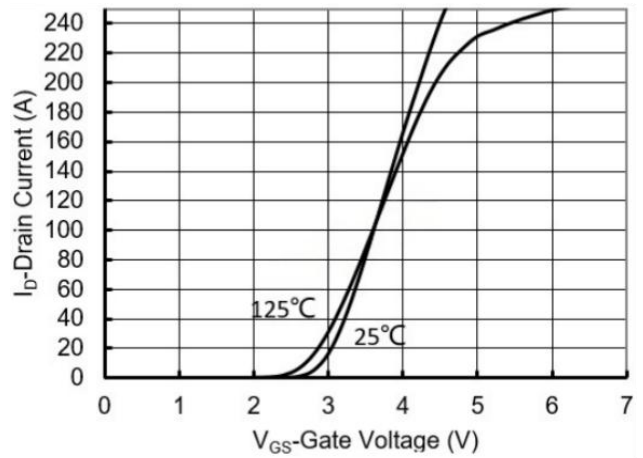

Figure2. Transfer Characteristics

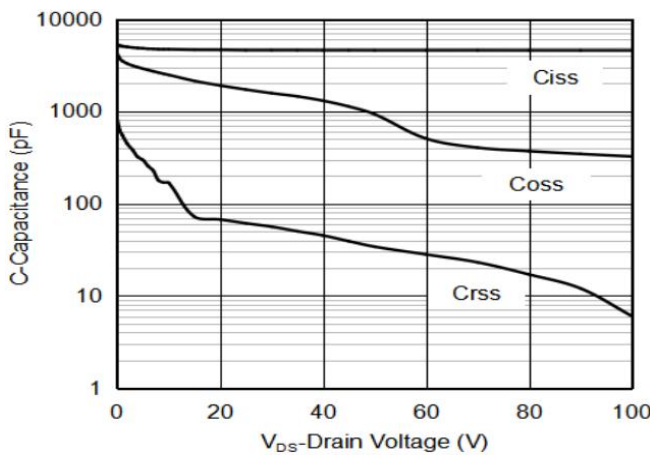

Figure3. Capacitance Characteristics

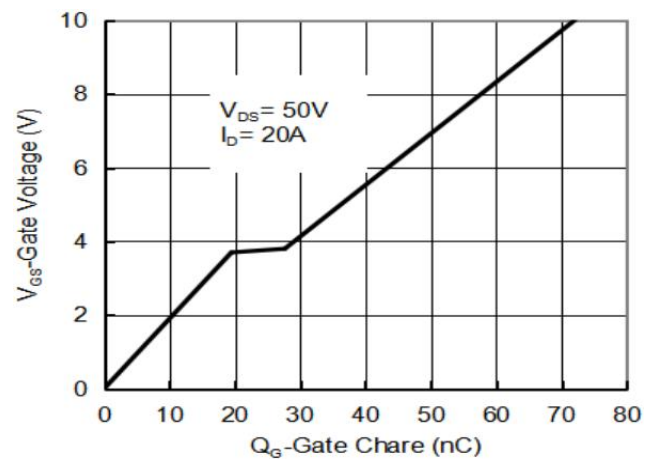

Figure4. Gate Charge

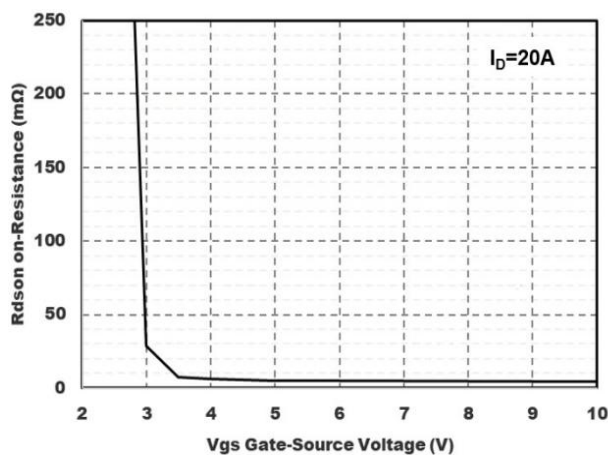

Figure5. : On-Resistance vs. Gate to Source Voltage

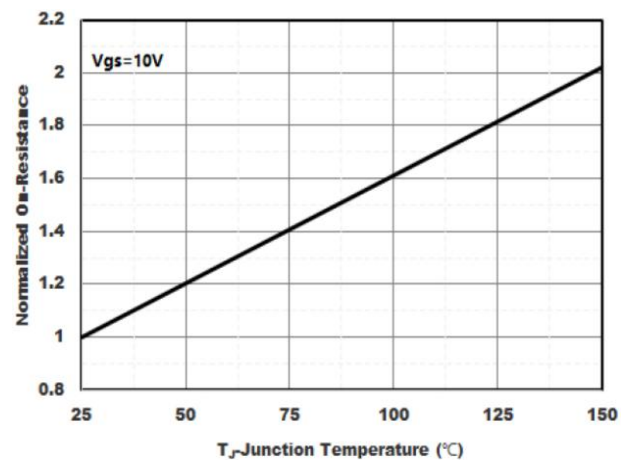

Figure6. Normalized On-Resistance

## Typical Characteristics

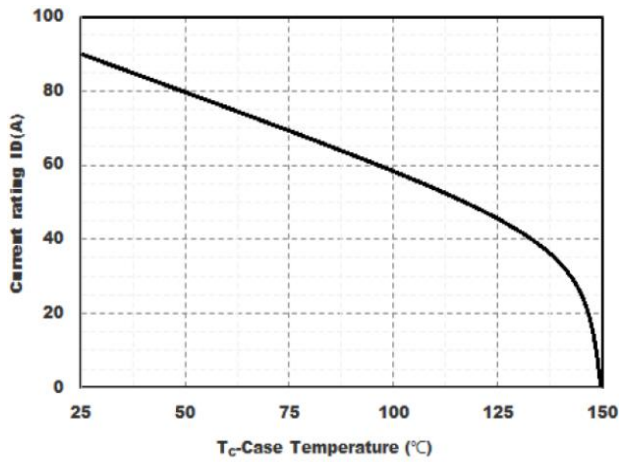

Figure7. Drain current

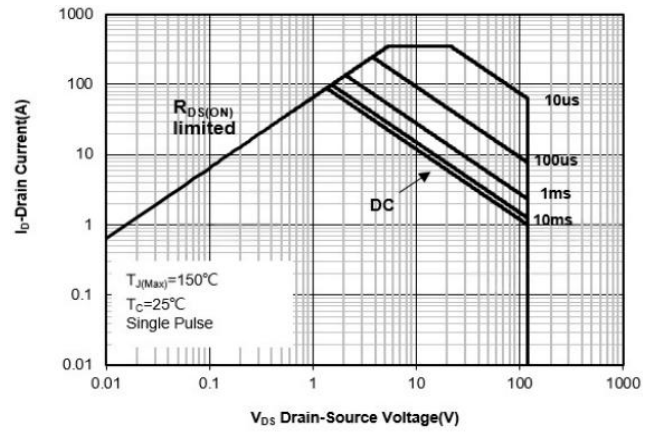

Figure8.Safe Operation Area

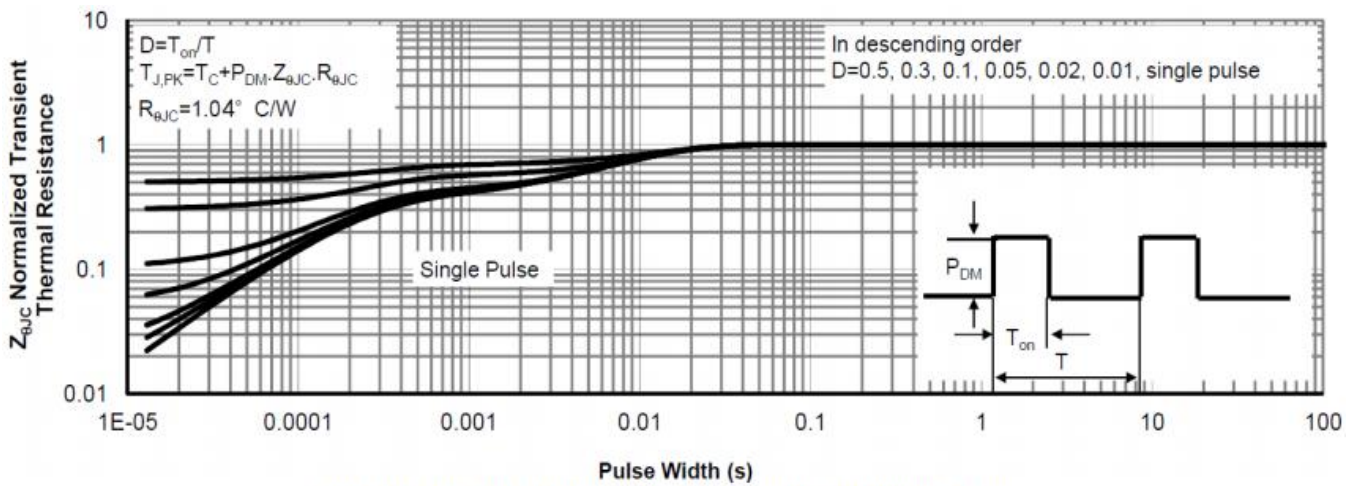
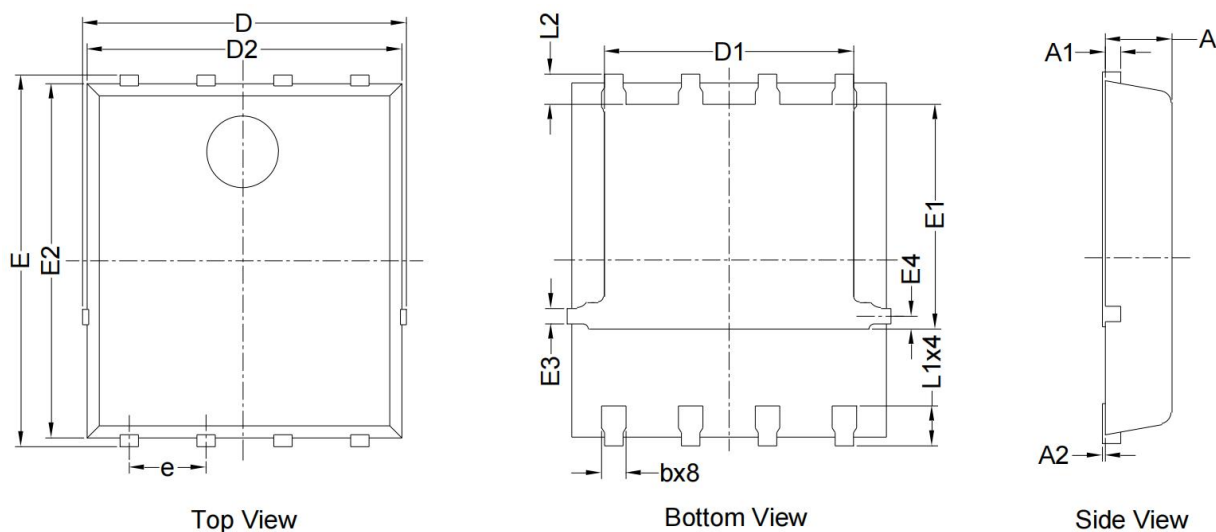

Figure9. Normalized Maximum Transient thermal impedance

### PDFN5\*6-8L Package Information



Symbol	Dimensions In Millimeters		Dimensions In Inches	
	Min.	Max.	Min.	Max.
D	5.150	5.550	0.203	0.219
E	5.950	6.350	0.234	0.250
A	1.000	1.200	0.039	0.047
A1	0.254 BSC.		0.010 BSC.	
A2	0.000	0.100	0.000	0.004
D1	3.920	4.320	0.154	0.170
E1	3.520	3.920	0.139	0.154
D2	5.000	5.400	0.197	0.213
E2	5.660	6.060	0.223	0.239
E3	0.254 REF.		0.010 REF.	
E4	0.210 REF.		0.008 REF.	
L1	0.560	0.760	0.022	0.030
L2	0.500 BSC.		0.020 BSC.	
b	0.310	0.510	0.012	0.020
e	1.270 BSC.		0.050 BSC.	