

Features

- Ultra low leakage: nA level
- Operating voltage: 5V
- Ultra low capacitance: 0.6pF typical
- Low clamping voltage
- Complies with following standards:
 - IEC 61000-4-2 (ESD) immunity test
 - Air discharge: ±25kV
 - Contact discharge: ±15kV
 - IEC61000-4-5 (Lightning) 5A (8/20µs)
- RoHS Compliant
- Compliant to Halogen-free

Dimensions DFN1610

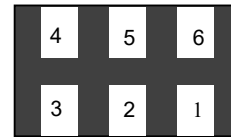

Applications

- USB 3.0 line
- HDMI1.4 Set-top box and digital TV
- 10/100/1000 Ethernet
- Notebook Computers
- SATA Ports
- MDDI Ports

Pin Configuration

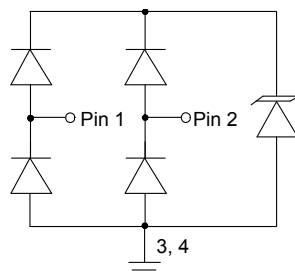

Pin	Identificaion
1,2	Input line
5,6	Output Lines (No Internal Connection)
3,4	Ground

Mechanical Characteristics

- Package: DFN1610
- Lead Finish: Lead Free
- UL Flammability Classification Rating 94V-0
- Quantity Per Reel: 3,000 pcs
- Reel Size: 7inch

Absolute Maximum Ratings (T_{amb}=25°C unless otherwise specified)

Parameter	Symbol	Value	Unit
Peak Pulse Power (8/20µs)	P _{pp}	65	W
ESD per IEC 61000-4-2 (Air)	V _{ESD}	± 25	Kv
ESD per IEC 61000-4-2 (Contact)		± 15	
Operating Temperature Range	T _J	-55 to +125	°C
Storage Temperature Range	T _{STJ}	-55 to +150	°C

Electrical Characteristics (TA=25°C unless otherwise specified)

Part Number	Device Marking	V _{RWM} (V)	V _{BR} (V)	I _T (mA)	V _c		I _R μA (Max)	C (Pf) (Typ.)
					(Max)	(@A)		
AESD0542T	0522P	5	5.6	1	15	5	0.5	0.6

Characteristic Curves

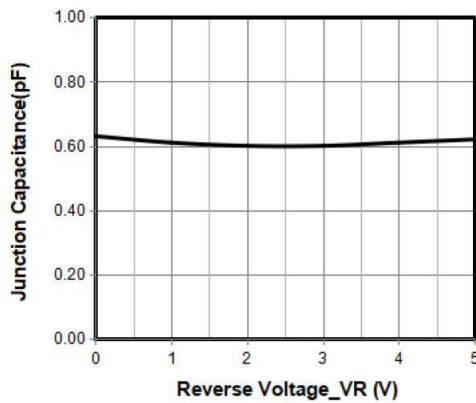

Junction Capacitance vs. Reverse Voltage

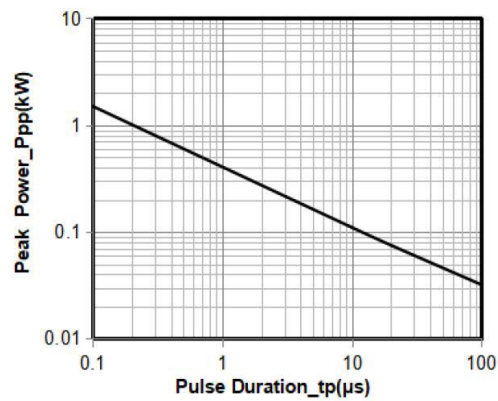

Peak Pulse Power vs. Pulse Time

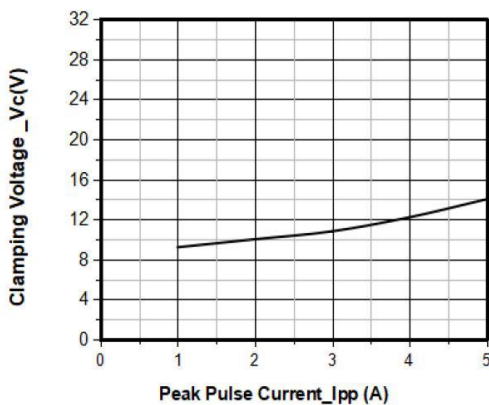

Clamping Voltage vs. Peak Pulse Current

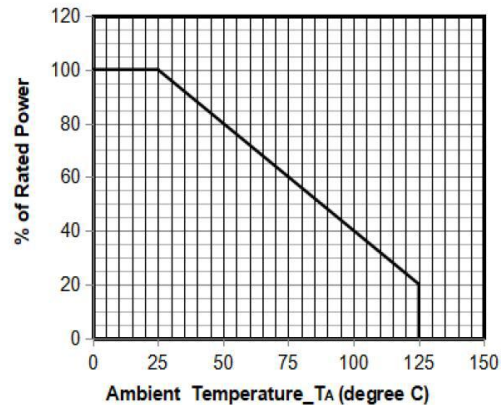

Power Derating Curve

DFN1610 Package Outline Drawing

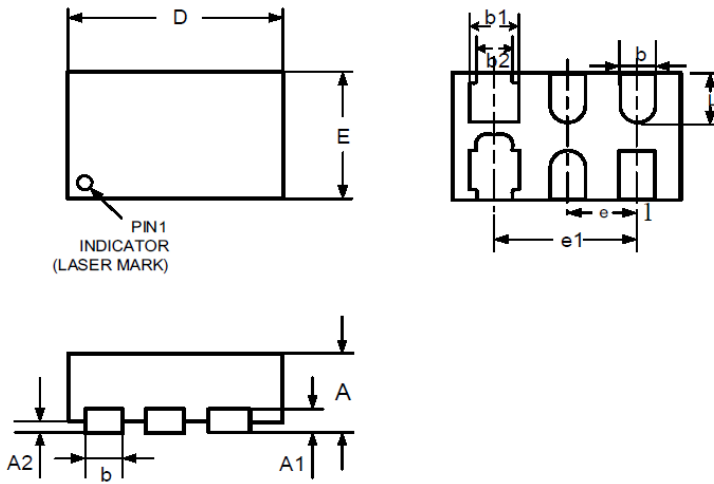

Symbol	Millimeters		Inches	
	Min.	Max.	Min.	Max.
D	1.55	1.65	0.061	0.065
E	0.95	1.05	0.037	0.041
L	0.33	0.43	0.013	0.017
b	0.15	0.25	0.006	0.010
b1	0.35	0.45	0.014	0.018
b2	0.25	0.35	0.010	0.014
e	0.50BSC		0.020BSC	
e1	1.00BSC		0.039BSC	
A	0.45	0.55	0.018	0.022
A1	0.15REF		0.006REF	
A2	0.00	0.05	0.000	0.002

Suggested Land Pattern

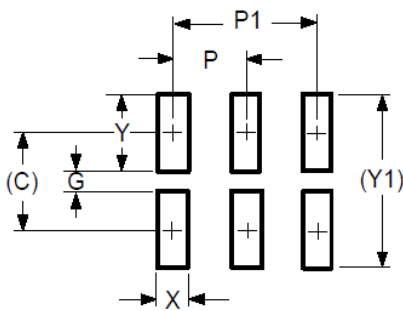

Symbol	Millimeters		Inches	
	Min.	Max.	Min.	Max.
C	0.60		0.024	
G	0.10		0.004	
P	0.50		0.020	
P1	1.0		0.039	
X	0.30		0.012	
Y	0.50		0.020	
Y1	1.10		0.043	