

Features

- ◆ The plastic package carries Underwriters Laboratory Flammability Classification 94V-0
- ◆ For surface mounted applications
- ◆ Fast switching for high efficiency
- ◆ Low reverse leakage
- ◆ Built-in strain relief, ideal for automated placement
- ◆ High forward surge current capability
- ◆ High temperature soldering guaranteed: 250°C/10 seconds at terminals
- ◆ Glass passivated chip junction
- ◆ Compliant to RoHS Directive 2011/65/EU
- ◆ Compliant to Halogen-free

Mechanical data

- ◆ **Case:** JEDEC DO-214AB molded plastic body
- ◆ **Terminals:** Solder plated, solderable per MIL-STD-750, Method 2026
- ◆ **Polarity:** Color band denotes cathode end
- ◆ **Mounting Position:** Any

Package outline

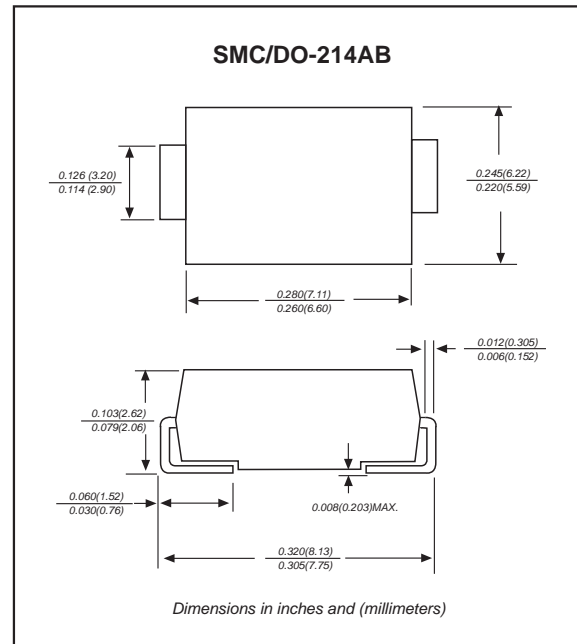

Maximum ratings and Electrical Characteristics (AT $T_A=25^\circ\text{C}$ unless otherwise noted)

PARAMETER	CONDITIONS	Symbol	MIN.	TYP.	MAX.	UNIT
Forward rectified current	See Fig.1	I_O			3.0	A
Forward surge current	8.3ms single half sine-wave (JEDEC methode)	I_{FSM}			100	A
Reverse current	$V_R = V_{RRM}$ $T_A = 25^\circ\text{C}$	I_R			5.0	μA
	$V_R = V_{RRM}$ $T_A = 100^\circ\text{C}$				50	
Thermal resistance	Junction to ambient NOTE 1	$R_{\theta JA}$		50		$^\circ\text{C}/\text{W}$
Diode junction capacitance	f=1MHz and applied 4V DC reverse voltage	C_J		60		pF
Storage temperature		T_{STG}	-65		+150	$^\circ\text{C}$

SYMBOLS	V_{RRM}^{*1} (V)	V_{RMS}^{*2} (V)	V_R^{*3} (V)	V_F^{*4} (V)	t_{rr}^{*5} (ns)	Operating temperature T_{Jr} ($^\circ\text{C}$)
RS3A-C	50	35	50	1.30	150	-55 to +150
RS3B-C	100	70	100			
RS3D-C	200	140	200			
RS3G-C	400	280	400		250	
RS3J-C	600	420	600			
RS3K-C	800	560	800			
RS3M-C	1000	700	1000	500		



- *1 Repetitive peak reverse voltage
- *2 RMS voltage
- *3 Continuous reverse voltage
- *4 Maximum forward voltage@ $I_F=3.0\text{A}$
- *5 Maximum Reverse recovery time, note 2

Note: 1.P.C.B. mounted with 0.2x0.2"(5.0x5.0mm) copper pad areas
2. Reverse recovery time test condition, $I_F=0.5\text{A}$, $I_R=1.0\text{A}$, $I_{RR}=0.25\text{A}$

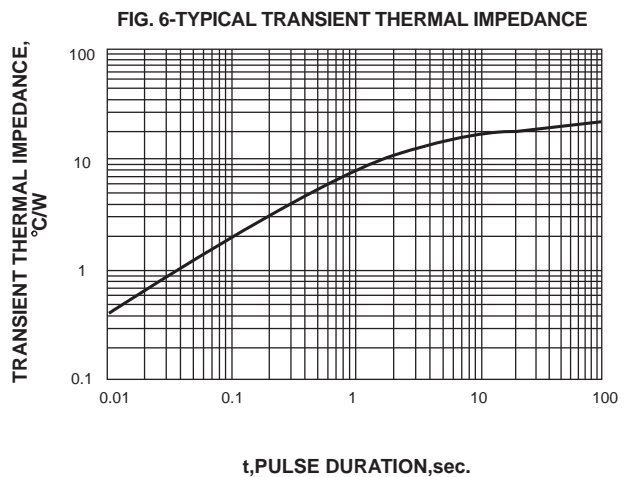
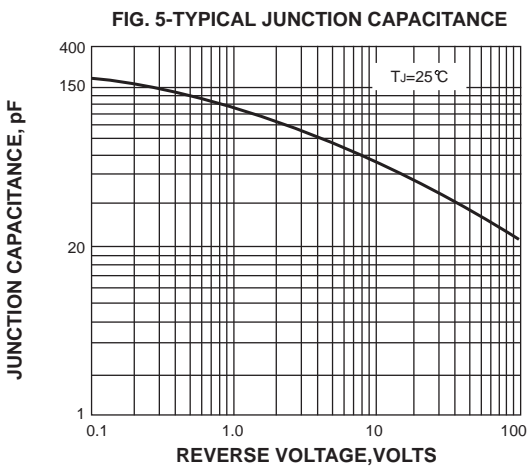
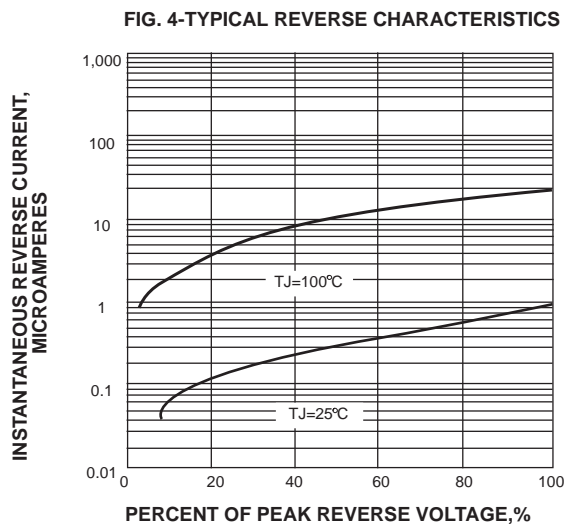
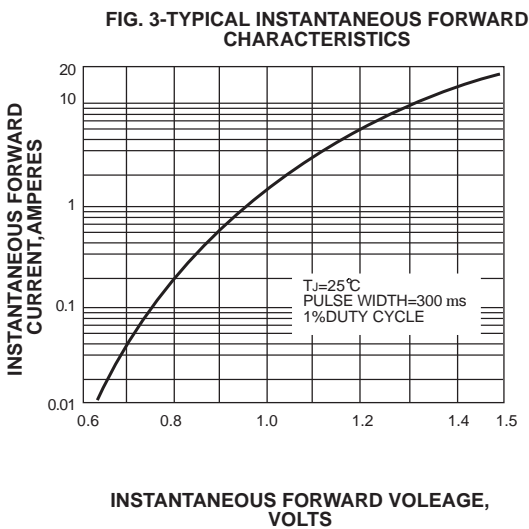
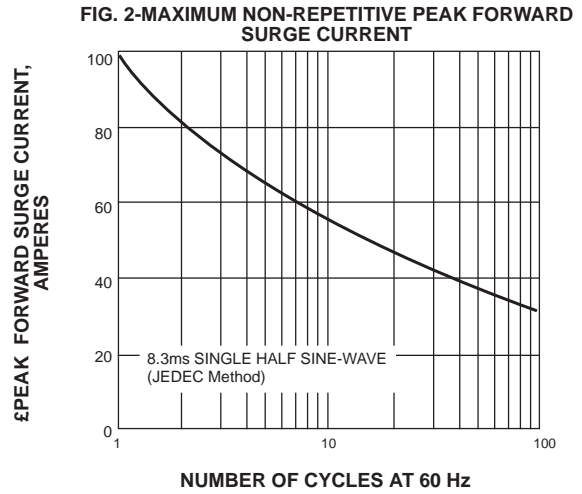
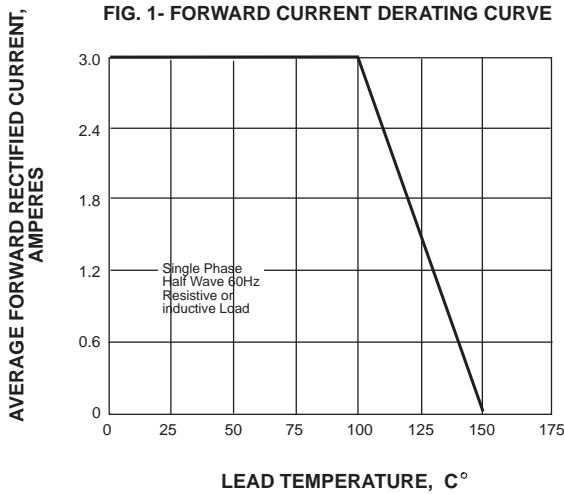
Rating and characteristic curves



Pinning information

Pin	Simplified outline	Symbol
Pin1 cathode Pin2 anode		

Marking

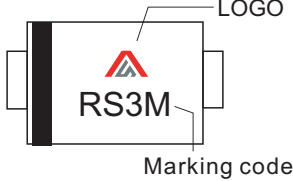
Type number	Marking code	Example
RS3A-C	RS3A	
RS3B-C	RS3B	
RS3D-C	RS3D	
RS3G-C	RS3G	
RS3J-C	RS3J	
RS3K-C	RS3K	
RS3M-C	RS3M	

Suggested solder pad layout



Dimensions in inches and (millimeters)

PACKAGE	A	B	C
SMC	0.132 (3.30)	0.100 (2.50)	0.176(4.40)